

OFFICE SUITES - Contemporary Laminate

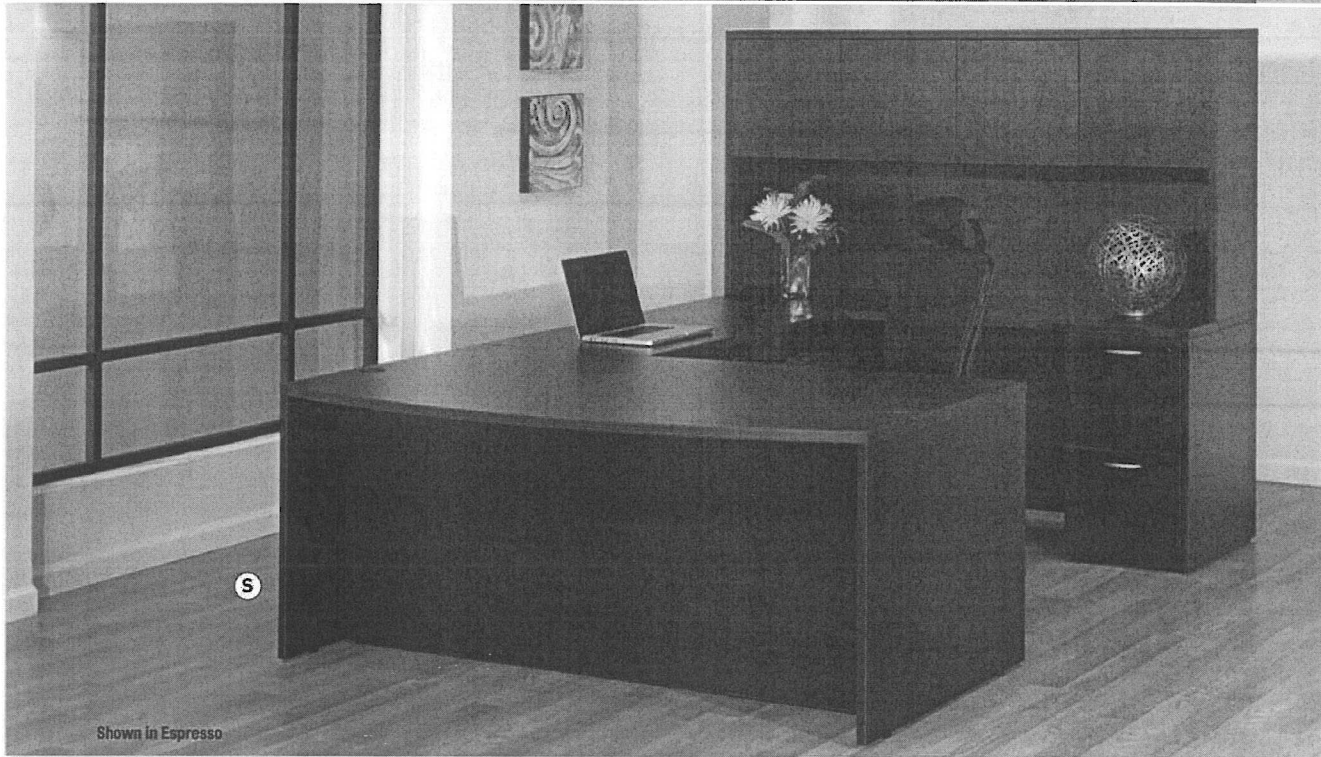

FurnitureAdvantage™

Extended Product Offering



Shown in Espresso

- L. 3-Shelf Bookcase (not shown)**
 36"W x 14"D x 42"H
 OSP NAP55 ___ ‡

LIST PRICE
 425.00- EA
- M. 5-Shelf Bookcase (not shown)**
 36"W x 14"D x 65"H
 OSP NAP56 ___ ‡

595.00- EA
- N. L-Shape Workstations (not shown)**
 66"W x 78"D x 29"H
 OSP NAPTYP9 ___ ‡

1930.00- EA

66"W x 78"D x 29"H
 OSP NAPTYP209 ___ ‡

Step Front With Wood Modesty Panel **2475.00- EA**
- O. L-Shape Workstations With Bow Front (not shown)**
 71"W x 88"D x 29"H
 OSP NAPTYP208 ___ ‡

Step Front With Wood Modesty Panel **2959.00- EA**

71"W x 88"D x 29"H
 OSP NATYP208G ___ ‡

Step Front With Glass Modesty Panel **2570.00- EA**
- P. Executive Offices (not shown)**
 71"W x 113"D x 65"H
 OSP NAPTYP11 ___ ‡

3810.00- EA

71"W x 113"D x 65"H
 OSP NAPTYP211 ___ ‡

Step Front With Wood Modesty Panel **4055.00- EA**

71"W x 113"D x 65"H
 OSP NATYP211G ___ ‡

Step Front With Glass Modesty Panel **4290.00- EA**

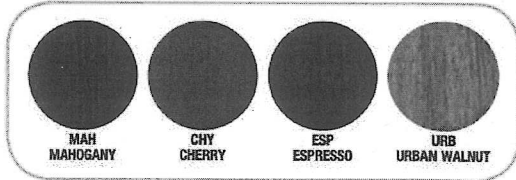

- Q. 36" Open Hutch For Lateral File/Storage Cabinet (not shown)**
 36"W x 14"D x 36"H
 OSP NAP53 ___ ‡

LIST PRICE
 369.00- EA
- R. 71" Glass Modesty Panel**
 For NAP89 and NAP01 only.
 OSP NAP88 ‡

290.00- EA
- S. U-Shape Workstations With Hutch**
 71"W x 112"D x 65"H
 OSP NAPTYP12 ___ ‡

3125.00- EA

71"W x 112"D x 65"H (not shown)
 OSP NAPTYP212 ___ ‡

3355.00- EA

71"W x 112"D x 65"H (not shown)
 OSP NATYP212G ___ ‡

3649.00- EA
- T. U-Shape Workstations With Hutch & File Storage (not shown)**
 107"W x 112"D x 65"H
 OSP NAPTYP213 ___ ‡

Step Front With Wood Modesty Panel **4935.00- EA**

107"W x 112"D x 65"H
 OSP NATYP213G ___ ‡

Step Front With Glass Modesty Panel **5320.00- EA**

Assembly needed. Please call for details.
 ‡ Cannot be shipped UPS.
 ‡‡ Cannot be shipped UPS Air. LA

Additional items available from manufacturer.

Available in 10-14 Business days **FA47**



OFFICE SUITES - Contemporary Laminate

Furniture Advantage™

Extended Product Offering

Furniture Components
Shown in Designer White/Raven



Typical 3



Typical 7

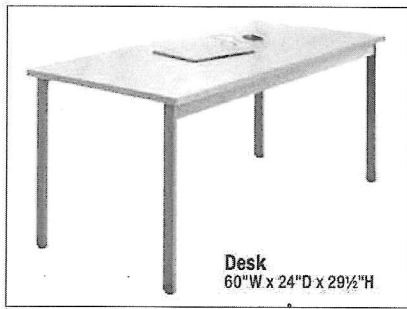

Desk
60"W x 24"D x 29½"H

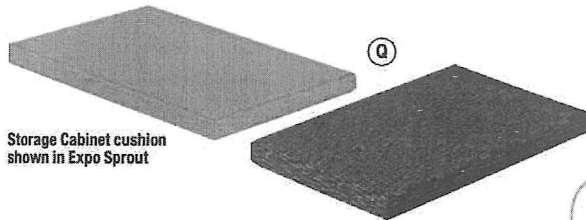

Storage Cabinet cushion shown in Expo Sprout

Mobile Pedestal cushion shown in Fuse Pepper

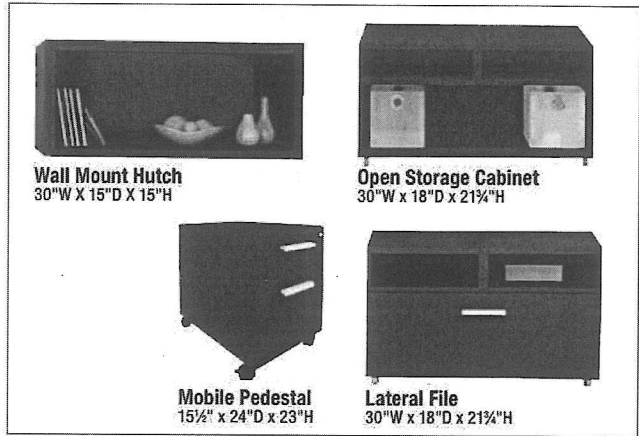

Wall Mount Hutch
30"W X 15"D X 15"H

Open Storage Cabinet
30"W x 18"D x 21¾"H

Mobile Pedestal
15½" x 24"D x 23"H

Lateral File
30"W x 18"D x 21¾"H

MAYLINE
e5 Typicals

- Providing solutions in a variety of price points
- Typicals can be reconfigured by making use of the long or short legs provided
- Chair and cushions sold separately
- Mobile pedestal not to be used for desk support
- Manufacturer Limited Lifetime Warranty

Available in Designer White desk/Raven storage elements (002) and Designer White desk/Designer White storage elements (AG2).

A. Typical 1 Consists of: (1) Desk: 4 long legs, (1) Wall Mount Hutch, (1) Mobile Pedestal.
MLN E5K1SV___ LIST PRICE 1747.00-~~EA~~

B. Typical 2 (not shown) Consists of: (1) Desk: 4 long/2 short legs, (1) Wall Mount Hutch, (1) Open Storage Cabinet.
MLN E5K2SV___ 1942.00-~~EA~~

C. Typical 3 Consists of: (1) Desk: 4 long/2 short legs, (1) Open Storage Cabinet, (1) Mobile Pedestal.

MLN E5K3SV___ LIST PRICE 2096.00-~~EA~~

D. Typical 4 (not shown) Consists of: (1) Desk: 4 long/2 short legs, (1) Wall Mount Hutch, (1) Lateral File.

MLN E5K4SV___‡ 2153.00-~~EA~~

E. Typical 5 (not shown) Consists of: (1) Desk: 4 long/2 short legs, (1) Lateral File, (1) Mobile Pedestal.

MLN E5K5SV___‡ 2346.00-~~EA~~

F. Typical 6 (not shown) Consists of: (1) Desk: 4 long/2 short legs, (2) Wall Mount Hutch, (1) Open Storage Cabinet.

MLN E5K6SV___ 2269.00-~~EA~~

G. Typical 7 Consists of: (1) Desk: 4 long/2 short legs, (1) Open Storage Cabinet, (1) Lateral File.

MLN E5K7SV___‡ LIST PRICE 2419.00-~~EA~~

H. Typical 8 Consists of: (1) Desk: 4 long/2 short legs, (1) Wall Mount Hutch, (1) Open Storage Cabinet, (1) Mobile Pedestal.

MLN E5K8SV___ 2462.00-~~EA~~

I. Typical 9 (not shown) Consists of: (1) Desk: 4 long/2 short legs, (2) Wall Mount Hutch, (1) Lateral File.

MLN E5K9SV___‡ 2579.00-~~EA~~

J. Typical 10 Consists of: (1) Desk: 4 long/2 short legs, (1) Wall Mount Hutch, (1) Lateral File, (1) Mobile Pedestal.

MLN E5K10SV___‡ 2772.00-~~EA~~

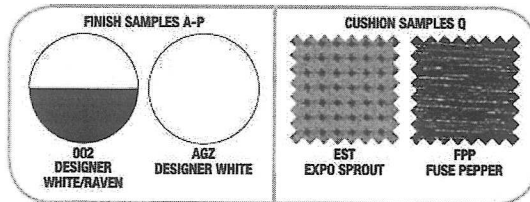

FA48

Available in 10-14 Business days



Additional items available from manufacturer.

Prices subject to change without notice. LA

OFFICE SUITES - Contemporary Laminate



FurnitureAdvantage™

Extended Product Offering

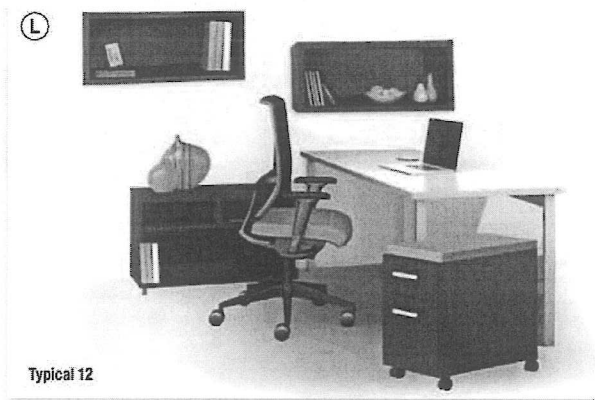

Typical 12



Typical 15



Typical 1



Typical 8



Typical 10



Typical 16

MAYLINE

K. Typical 11 (not shown) Consists of: (1) Desk: 4 long/2 short legs, (1) Wall Mount Hutch, (1) Open Storage Cabinet, (1) Lateral File.

MLN E5K11SV___‡ LIST PRICE
2838.00-EA

L. Typical 12 Consists of: (1) Desk: 4 long/2 short legs, (2) Wall Mount Hutch, (1) Open Storage Cabinet, (1) Mobile Pedestal.

MLN E5K12SV___‡ 2888.00-EA

M. Typical 13 (not shown) Consists of: (1) Desk: 4 long/2 short legs, (1) Open Storage Cabinet, (1) Lateral File, (1) Mobile Pedestal.

MLN E5K13SV___‡ 3032.00-EA

N. Typical 14 (not shown) Consists of: (1) Desk: 4 long/2 short legs, (2) Wall Mount Hutch, (1) Lateral File, (1) Mobile Pedestal.

MLN E5K14SV___‡ 3188.00-EA

O. Typical 15 Consists of: (1) Desk: 4 long/2 short legs, (2) Wall Mount Hutch, (1) Open Storage Cabinet, (1) Lateral File.

MLN E5K15SV___‡ LIST PRICE
3264.00-EA

P. Typical 16 Consists of: (1) Desk: 4 long/2 short legs, (2) Wall Mount Hutch, (1) Open Storage Cabinet, (1) Lateral File, (1) Mobile Pedestal.

MLN E5K16SV___‡ 3984.00-EA

Q. Cushions Available in Expo Sprout (EST) or Fuse Pepper (FPP).

Storage Cabinet Cushion

29"W x 17"D x 2"H
MLN EZSC30___ 297.00-EA

Mobile Pedestal Cushion

15 1/2"W x 23"D x 2"H
MLN EZSC15___ 277.00-EA

Assembly needed. Please call for details.

‡Cannot be shipped UPS.

‡‡Cannot be shipped UPS Air. LA



Additional items available from manufacturer.

Available in 10-14 Business days

FA49



OFFICE SUITES - Contemporary Laminate

FurnitureAdvantage™

Extended Product Offering

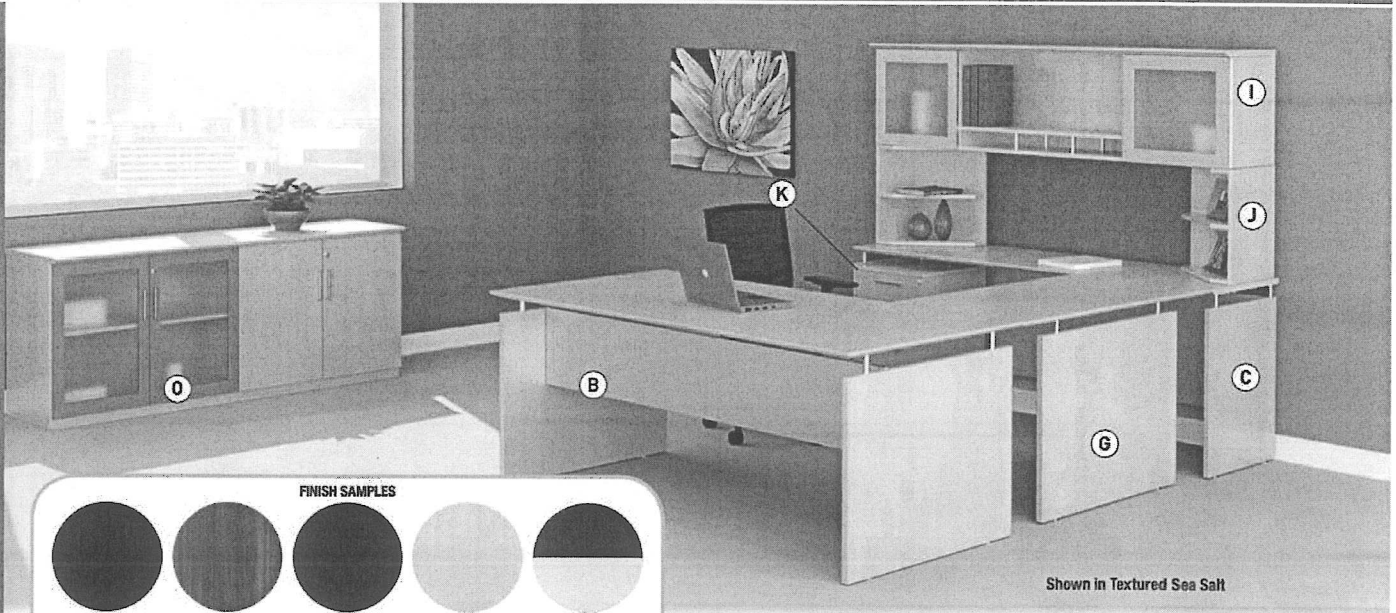

Shown in Textured Sea Salt

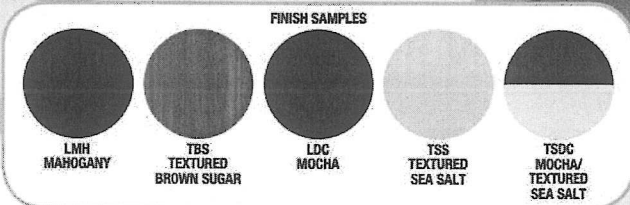

MAYLINE

Medina Laminate Desking



- Laminate casegoods that combine Italian-influenced designs, style and durability
- 1" thick floating worksurface with a beveled edge and silver detailing
- Manufacturer Limited Lifetime Warranty

Available in Mahogany (LMH), Textured Brown Sugar (TBS), Mocha (LDC), Textured Sea Salt (TSS) and Textured Sea Salt/Mocha (TSDC) finishes.

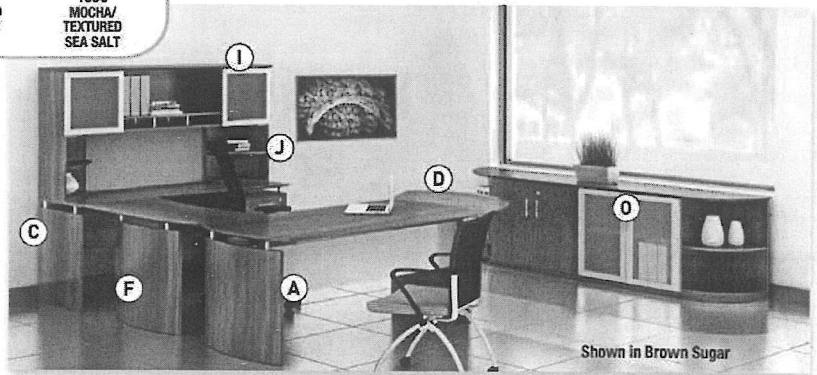

Shown in Brown Sugar

A. Curved Desks

- 72"W x 36"D x 29½"H
MLN MND72 ___\$
- 63"W x 36"D x 29½"H
MLN MND63 ___\$

LIST PRICE
670.00-EA
635.00-EA

B. Straight Desks

- 72"W x 36"D x 29½"H
MLN MND572 ___\$
- 63"W x 36"D x 29½"H
MLN MND563 ___\$

670.00-EA
635.00-EA

C. Credenzas

- 72"W x 20"D x 29½"H
MLN MNCNZ72 ___\$
- 63"W x 20"D x 29½"H
MLN MNCNZ63 ___\$

435.00-EA
390.00-EA

D. Curved Desk Extensions

- 47"W x 28"D x 29½"H
MLN MNEXTR ___\$
- MLN MNEXTL ___\$

Right 405.00-EA
Left 405.00-EA

E. Curved Desk Returns With Pencil/Box/File Pedestal (not shown)

Works only with curved desks.

- 63"W x 24"D x 29½"H
MLN MNRTPR ___\$
- MLN MNRTPL ___\$

Right 715.00-EA
Left 715.00-EA

F. Curved Bridges

- Works only with curved desks.
- 48"W x 24"D x 29½"H
MLN MNBDDR ___\$
- MLN MNBDDL ___\$

Right 335.00-EA
Left 335.00-EA

G. Non-Handed Straight Bridges

- Works only with Straight Desks and Credenzas
- 48½"W x 20"D x 29½"H
MLN MGBDG ___\$

335.00-EA

H. Non-Handed Returns (not shown)

- Works only with Straight Desks and Credenzas
- 48½"W x 20"D x 29½"H
MLN MNRT ___\$

344.00-EA

I. Wall Mount Hutches

- Can be used on both straight and curved desks.
- 72"W x 15"D x 18½"H
MLN MNH72 ___\$
- 63"W x 15"D x 18½"H
MLN MNH63 ___\$

775.00-EA
665.00-EA

J. Corner Support

- For Wall Mount Hutch
- 15"W x 15"D x 20"H
MLN MNPO ___\$

110.00-EA

K. Box/Box/File Mobile Pedestal

- 15½"W x 18"D x 26½"H
MLN MNBF ___\$

440.00-EA

L. File/File Mobile Pedestal (not shown)

- 15½"W x 18"D x 26½"H
MLN MNFF ___\$

LIST PRICE
405.00-EA

M. 5-Shelf Bookcase (not shown)

- 36"W x 13"D x 68"H
MLN MNVB5 ___\$

595.00-EA

N. Lateral File (not shown)

- 36"W x 20"D x 29½"H
MLN MVLF ___\$

835.00-EA

O. Low Wall Cabinet

- 72"W x 20"D x 29½"H
MLN MVLC ___\$

970.00-EA

P. Quarter Round Bookcase

- 20"W x 20"D x 29½"H
MLN MVBQ2 ___\$

215.00-EA

Q. Storage Cabinets (not shown)

- 36"W x 20"D x 39½"H
MLN MSC ___\$

692.00-EA

R. Glass Display Cabinet (not shown)

- 36"W x 20"D x 39½"H
MLN MGDC ___\$

895.00-EA

S. LED Under Cabinet Task Lighting (not shown)

- 16"W x ½"D x ½"H
MLN EZDP ___\$

185.00-EA

FA50

Available in 10-14 Business days



Additional items available from manufacturer.

Prices subject to change without notice. LA

OFFICE SUITES - Contemporary Laminate



FurnitureAdvantage™ Extended Product Offering

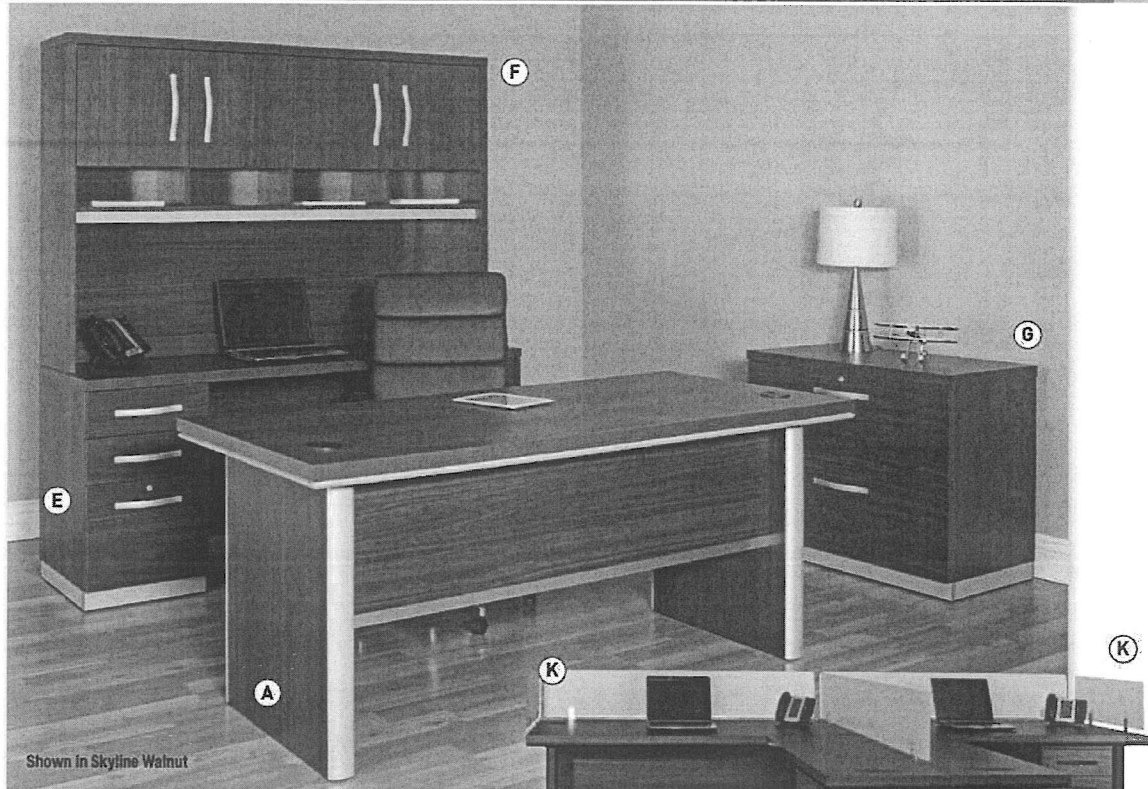

Shown In Skyline Walnut

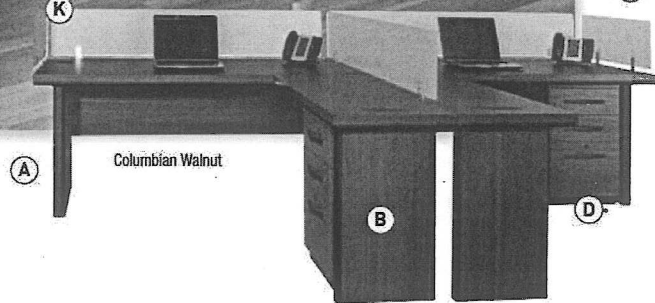

Columbian Walnut

MARTIN
FURNITURE

Paladin Series Columbian Walnut accented with Black hardware and Black accents. Skyline Walnut accented with Silver Hardware and Silver Accents.

Available in Columbian Walnut (W) and Skyline Walnut (G) finishes.

A. Executive Desk Two grommets, wire management through leg interior. Can attach with the return to make a left or right L desk.
72"W x 32"D x 30 1/2"H
MRT P_720‡
LIST PRICE 677.00-**EA**

B. Return Wire management through leg interior, flush mounted power center. Can attach to the executive desk on left or right side.
48"W x 20"D x 30 1/2"H
MRT P_720R‡
342.00-EA****

C. Two-Drawer File Two letter/legal file drawers. Bottom drawer locks.
18"W x 19 1/2"D x 27 1/4"H
MRT P_201‡
499.00-EA****

D. Mobile File One locking letter/legal file drawer, two utility drawers, casters.
18"W x 19 1/2"D x 27 1/4"H
MRT P_202‡
493.00-EA****

E. Credenza Two letter/legal file drawers, four utility drawers, flush mounted power center.
72"W x 21"D x 30 1/2"H
MRT P_729‡
1310.00-EA****

F. Hutch Four soft closing doors with adjustable shelf behind each door and four storage cubbies.
72"W x 11 1/2"D x 47 1/4"H
MRT P_722‡
962.00-EA****

G. Lateral File Two letter/legal file drawers with top drawer locking.
36"W x 21"D x 30 1/2"H
MRT P_450‡
LIST PRICE 738.00-**EA**

H. Wardrobe (not shown) Three fixed storage shelves, two doors, coat hook. Fits on the lateral file.
36"W x 21"D x 47 1/4"H
MRT P_314‡
685.00-EA****

I. Bookcase (not shown) Open design with four adjustable shelves and two fixed shelves.
36"W x 11 1/2"D x 78"H
MRT P_3678‡
645.00-EA****

J. Bookcase Two lower doors, four adjustable shelves and two fixed shelves.
36"W x 11 1/2"D x 78"H
MRT P_3678D‡
795.00-EA****

K. Glass Privacy Screens One frosted tempered glass with two mounting brackets that attach to executive desk and/or return.
70"W x 1/4"D x 11 1/4"H
MRT P_GPS70‡
28"W x 1/4"D x 11 1/4"H
MRT P_GPS26‡
178.00-EA****
137.00-EA****

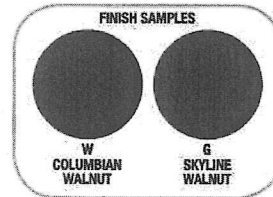

Skyline Walnut

Skyline Walnut

Assembly needed. Please call for details.

‡Cannot be shipped UPS.

‡‡Cannot be shipped UPS Air. LA



Additional items available from manufacturer.

Available in 10-14 Business days

FA51



OFFICE SUITES - Contemporary Laminate

FurnitureAdvantage™

Extended Product Offering

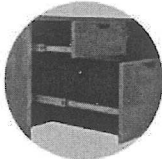
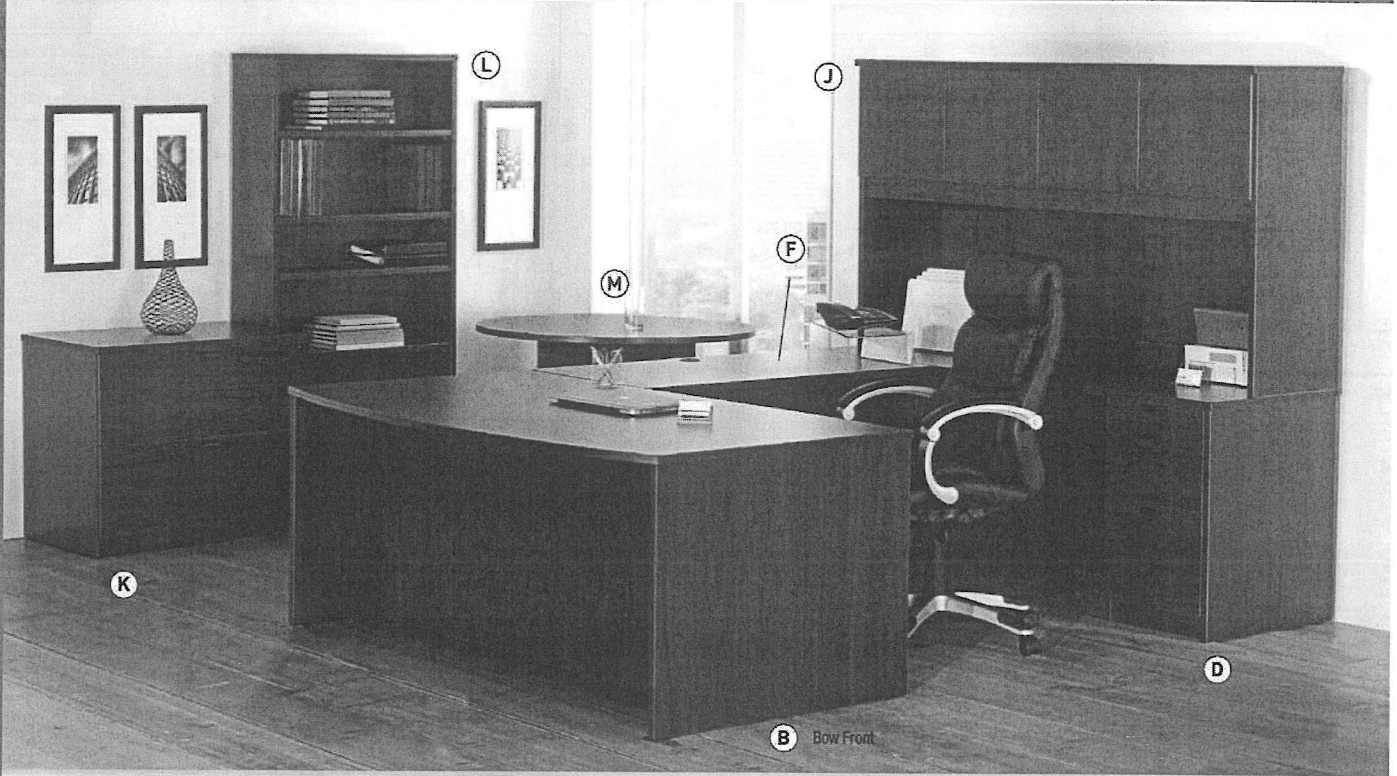

FULL SUSPENSION BALL-BEARING GLIDES

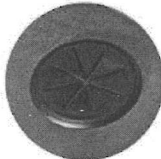

GROMMET

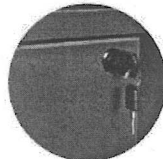

LOCKING PEDESTAL DRAWERS



- All items are shipped assembled with the exception of the bridge, corner unit & conference table
- All surfaces are manufactured with 45 lb. density particleboard and are finished on both sides with high-performance thermally infused melamine
- The surfaces are mar-, burn- and impact-resistant
- Tops and end panels are all 1" thick
- All tops, end panels and drawer fronts have 3mm edge banding
- All desks are standard with full-height modesty panels
- Pedestals have locking drawers
- Box and file drawers have 100 lb. full suspension ball-bearing slides
- File drawers are standard with high sides to accommodate file folders
- Lateral files have anti-tip mechanism, full suspension ball-bearing slides and lock
- All units have 3/4" adjustable glides
- Grommets are standard on returns, bridges and corner units

Available in Cherry finish, as shown.

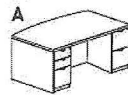

A. Double Pedestal Desks

- File/File on right, Box/Box/File on left
- 71"W x 42"D x 29"H
EUT BBF4271FFC‡
- 71"W x 36"D x 29"H
EUT BBF3671FFC‡
- 66"W x 30"D x 29"H
EUT BBF3066FFC‡
- 60"W x 30"D x 29"H
EUT BBF3060FFC‡

Bow Front

LIST PRICE
1094.00-EA

1050.00-EA

1027.00-EA

995.00-EA

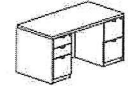

B. Single Left Pedestal Desks

- Box/Box/File
- 71"W x 42"D x 29"H
EUT BBF4271C‡
- 71"W x 36"D x 29"H
EUT BBF3671C‡
- 66"W x 30"D x 29"H
EUT BBF3066C‡
- 60"W x 30"D x 29"H
EUT BBF3060C‡
- 48"W x 30"D x 29"H
EUT BBF3048C‡

Bow Front

740.00-EA

699.00-EA

675.00-EA

644.00-EA

632.00-EA



C. Single Right Pedestal Desks (not shown)

- Box/Box/File
- 71"W x 42"D x 29"H
EUT 4271BBFC‡
- 71"W x 36"D x 29"H
EUT 3671BBFC‡
- 66"W x 30"D x 29"H
EUT 3066BBFC‡
- 60"W x 30"D x 29"H
EUT 3060BBFC‡
- 48"W x 30"D x 29"H
EUT 3048BBFC‡

Bow Front

740.00-EA

699.00-EA

675.00-EA

644.00-EA

632.00-EA

FA52

Available in 10-14 Business days



Additional items available from manufacturer.

Prices subject to change without notice. LA

OFFICE SUITES - Contemporary Laminate



FurnitureAdvantage™

Extended Product Offering

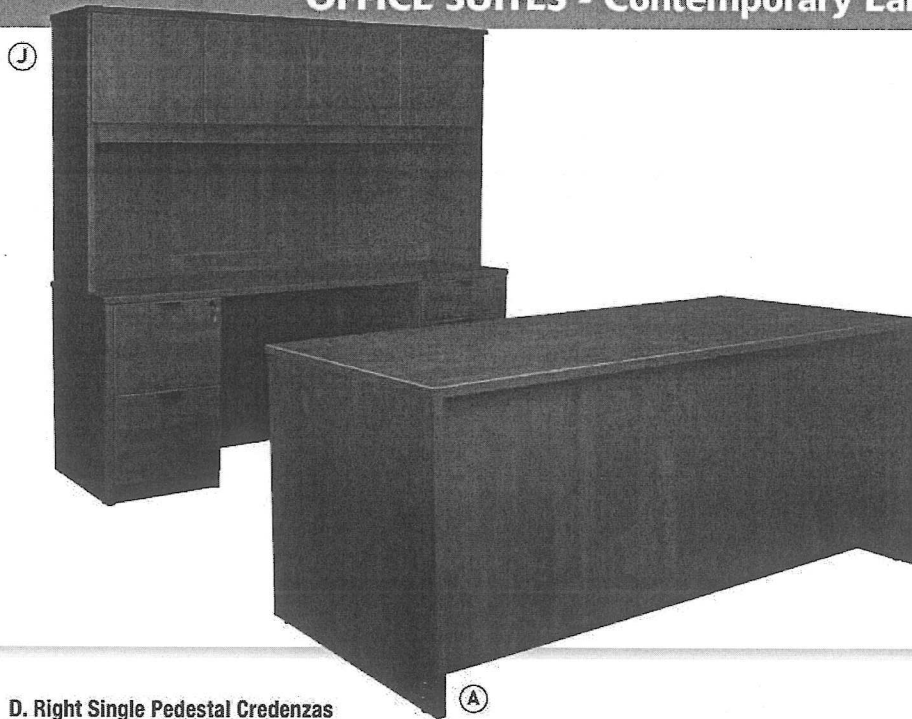

D. Right Single Pedestal Credenzas

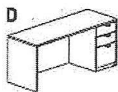

Box/Box/File
71"W x 24"D x 29"H
EUT 2471BBFC‡
86"W x 24"D x 29"H
EUT 2466BBFC‡

LIST PRICE
675.00-EA
653.00-EA

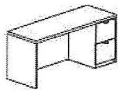

File/File
71"W x 24"D x 29"H
EUT 2471FFC‡
86"W x 24"D x 29"H
EUT 2466FFC‡

675.00-EA
653.00-EA

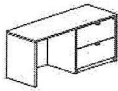

Locking Lateral File (not shown)
71"W x 24"D x 29"H
EUT 2471LFC‡
86"W x 24"D x 29"H
EUT 2466LFC‡

885.00-EA
862.00-EA

E. Left Single Pedestal Credenzas (not shown)

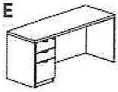

Box/Box/File
71"W x 24"D x 29"H
EUT BBF2471C‡
86"W x 24"D x 29"H
EUT BBF2466C‡

675.00-EA
653.00-EA



File/File
71"W x 24"D x 29"H
EUT FF2471C‡
86"W x 24"D x 29"H
EUT FF2466C‡

675.00-EA
653.00-EA

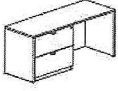

Locking Lateral File
71"W x 24"D x 29"H
EUT LF2471C‡
86"W x 24"D x 29"H
EUT LF2466C‡

885.00-EA
862.00-EA

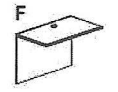

F. Bridge
48"W x 24"D x 29"H
EUT BR2448C‡

228.00-EA



G. Double Pedestal Credenzas (not shown)

Box/Box/File on left, File/File on right

71"W x 24"D x 29"H
EUT BBF2471FFC‡
86"W x 24"D x 29"H
EUT BBF2466FFC‡

1027.00-EA
1095.00-EA

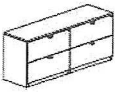

Double Lateral File
71"W x 24"D x 29"H
EUT LF2471LFC‡

1446.00-EA

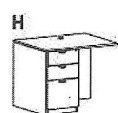

H. Left Returns (not shown)

Box/Box/File
48"W x 24"D x 29"H
EUT RBBF2448C‡
42"W x 24"D x 29"H
EUT RBBF2442C‡

LIST PRICE
677.00-EA
667.00-EA

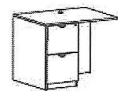

File/File
48"W x 24"D x 29"H
EUT RFF2448C‡
42"W x 24"D x 29"H
EUT RFF2442C‡

677.00-EA
667.00-EA

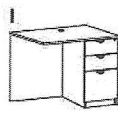

I. Right Returns (not shown)

Box/Box/File
48"W x 24"D x 29"H
EUT 2448RBBFC‡
42"W x 24"D x 29"H
EUT 2442RBBFC‡

677.00-EA
664.00-EA

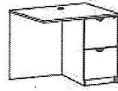

File/File
48"W x 24"D x 29"H
EUT 2448RFFC‡
42"W x 24"D x 29"H
EUT 2442RFFC‡

677.00-EA
664.00-EA

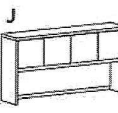

J. Hutches

71"W x 16"D x 39"H
EUT H713916C‡
66"W x 16"D x 39"H
EUT H663916C‡

454.00-EA
431.00-EA

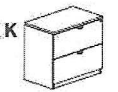

K. 36" Lateral File – Two Drawer

34½"W x 22"D x 29"H
EUT LF2236C‡

562.00-EA

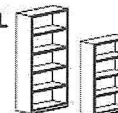

L. Bookcases

34"W x 12"D x 69"H
EUT BC346912C‡
34"W x 12"D x 48"H
EUT BC344812C‡

5-Shelf 388.00-EA
4-Shelf 320.00-EA



M. 42" Round Conference Table

42"W x 42"D x 29"H
EUT RT42C‡

392.00-EA

Assembly needed. Please call for details.

‡Cannot be shipped UPS.

‡‡Cannot be shipped UPS Air. LA



Additional items available from manufacturer.

Available in 10-14 Business days

FA53



OFFICE SUITES - Contemporary Laminate

FurnitureAdvantage™

Extended Product Offering

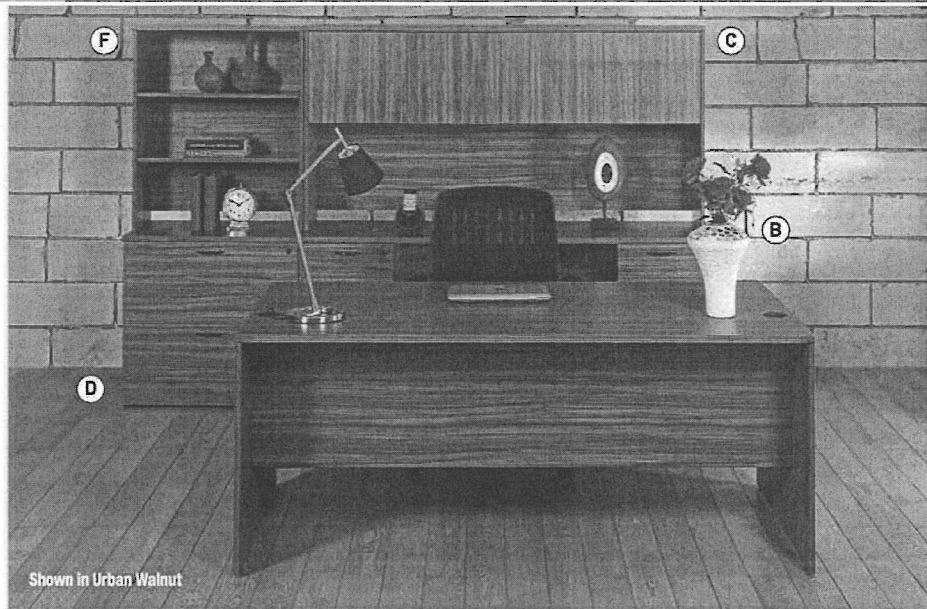

Shown in Urban Walnut

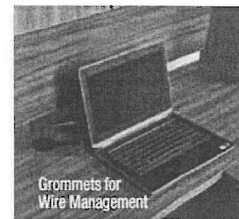

Lodi Collection

- Lodi combines open, contemporary appearance and modern quality details with space-saving, budget-saving solutions
- The 3/4 modesty panels provide easy access to wall outlets
- Full-width cord-drop on all hutches for cord management
- The contemporary, clean-grain design Urban Walnut features an embossed wood-like finish
- See page FA46-FA47 for Napa Series, mix and match items.
- Available in Urban Walnut (URB) and Espresso (ESP) finishes.

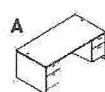
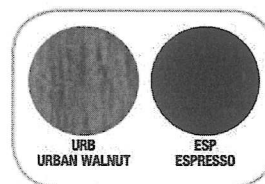

A. Double Pedestal Desks

- 71"W x 35"D x 29"H
OSP LODTYP2 ___ ‡
- 66"W x 30"D x 29"H
OSP LODTYP3 ___ ‡
- 60"W x 30"D x 29"H
OSP LODTYP4 ___ ‡

LIST PRICE
1080.00-EA
1015.00-EA
985.00-EA

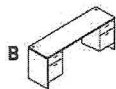

B. Double Pedestal Credenza

- 71"W x 20"D x 29"H
OSP LODTYP5 ___ ‡

925.00-EA

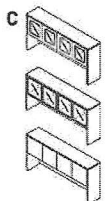

C. Overhead With Doors

- 71"W x 14"D x 36"H
OSP LOD41 ___ ‡ Wood/Glass Doors 690.00-EA
- 71"W x 14"D x 36"H
OSP LOD42 ___ ‡ Aluminum/Glass Doors 705.00-EA
- 71"W x 14"D x 36"H
OSP LOD44 ___ ‡ Wood Doors 640.00-EA



E. 2-Door Storage Cabinet (not shown)

- 30"W x 20"D x 29"H
OSP LOD13 ___ ‡

LIST PRICE
390.00-EA



F. Open Hutch

- 30"W x 12"D x 36"H
OSP LOD53 ___ ‡

260.00-EA



G. 2-Shelf Bookcase (not shown)

- 30"W x 12"D x 29"H
OSP LOD55 ___ ‡

325.00-EA

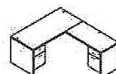

H. L-Shape Desk (not shown)

- 66"W x 78"D x 29"H
OSP LODTYP9 ___ ‡ 1295.00-EA
- 66"W x 72"D x 29"H
OSP LODTYP32 ___ ‡ 1250.00-EA
- 60"W x 72"D x 29"H
OSP LODTYP34 ___ ‡ 1220.00-EA



D. Lateral File

- 30"W x 20"D x 29"H
OSP LOD12 ___ ‡

750.00-EA

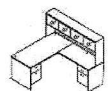

I. L-Shape Desk With Hutch (not shown)

- 66"W x 72"D x 29"H
OSP LODTYP31 ___ ‡

1040.00-EA

FA54

Available in 10-14 Business days



Additional items available from manufacturer.

Prices subject to change without notice. LA

OFFICE SUITES - Contemporary Laminate



FurnitureAdvantage™

Extended Product Offering

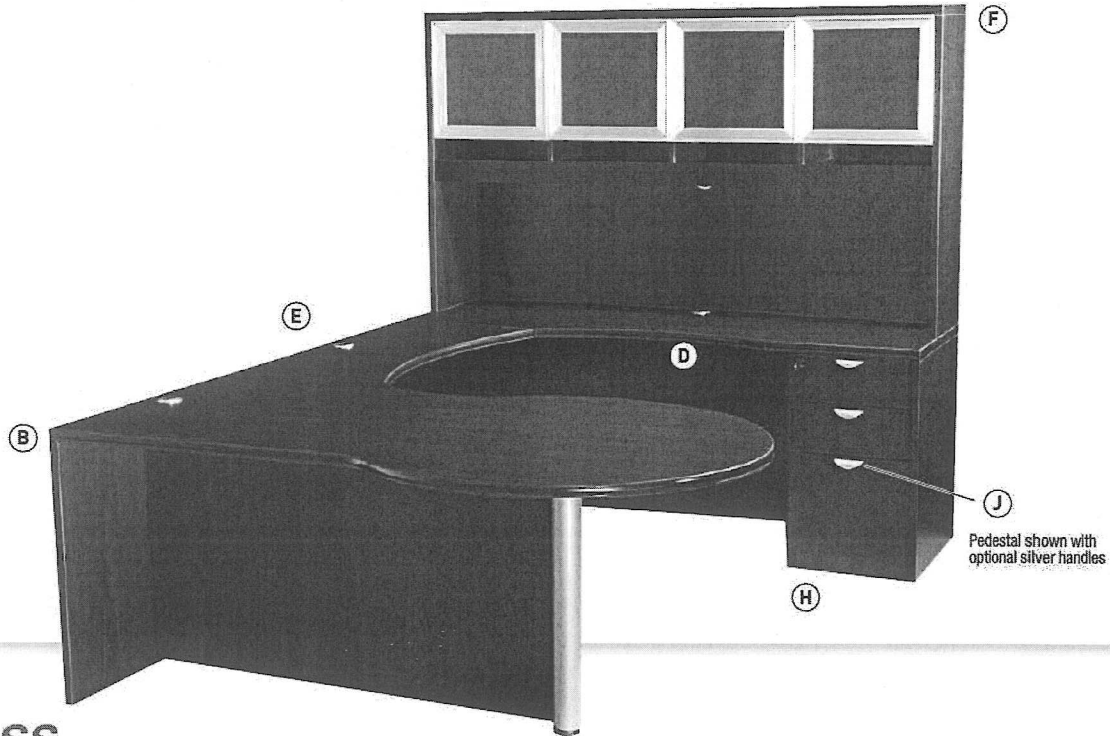

BOSS
Office Products

Curve Series

- 1" laminated thermal-fused melamine high-gloss finish
- Full pedestals are standard with side and corner interchangeable locks
- Free-standing units are equipped with leveling glides and have grommets for wire management
- Full modesty panels on all desks, bridges and credenzas
- Full extension rails on all file drawers
- Full 3mm tri-curved edge banding
- Black handles standard

Available in Mahogany finish, as shown.

A. Bow-Front Curved Desk Shell (not shown)
71"W x 35 1/4"D x 29 1/2"H
BOP N689M‡
LIST PRICE 469.00-EA

B. Right Curved Pedestal Desk Shell
71"W x 41"D x 29 1/2"H
BOP N647RM‡ 439.00-EA

C. Left Curved Pedestal Desk Shell (not shown)
71"W x 41"D x 29 1/2"H
BOP N647LM‡ 439.00-EA

D. Curved Credenza
71"W x 24"D x 29 1/2"H
BOP N643M‡ 369.00-EA

E. Curved Bridge
41"W x 20"D x 29 1/2"H
BOP N697M‡ LIST PRICE 175.00-EA

F. Hutch With Glass Doors
Tackboard not included.
71"W x 15"D x 41"H
BOP N644GM‡ 609.00-EA

G. Box/File Hanging Pedestal (not shown)
16"W x 18"D x 19"H
BOP N108M‡ 229.00-EA

H. Box/Box/File Full Height Pedestal
16"W x 22"D x 28 1/2"H
BOP N166M‡ 349.00-EA

I. File/File Full Height Pedestal (not shown)
16"W x 22"D x 28 1/2"H
BOP N176M‡ 359.00-EA

J. 32MM Silver Handle
BOP TUN005MHS 6.00-EA

Assembly needed. Please call for details.

‡Cannot be shipped UPS.

‡‡Cannot be shipped UPS Air. LA



Additional items available from manufacturer.

Available in 10-14 Business days

FA55



OFFICE SUITES - Contemporary Laminate

Furniture Advantage™

Extended Product Offering

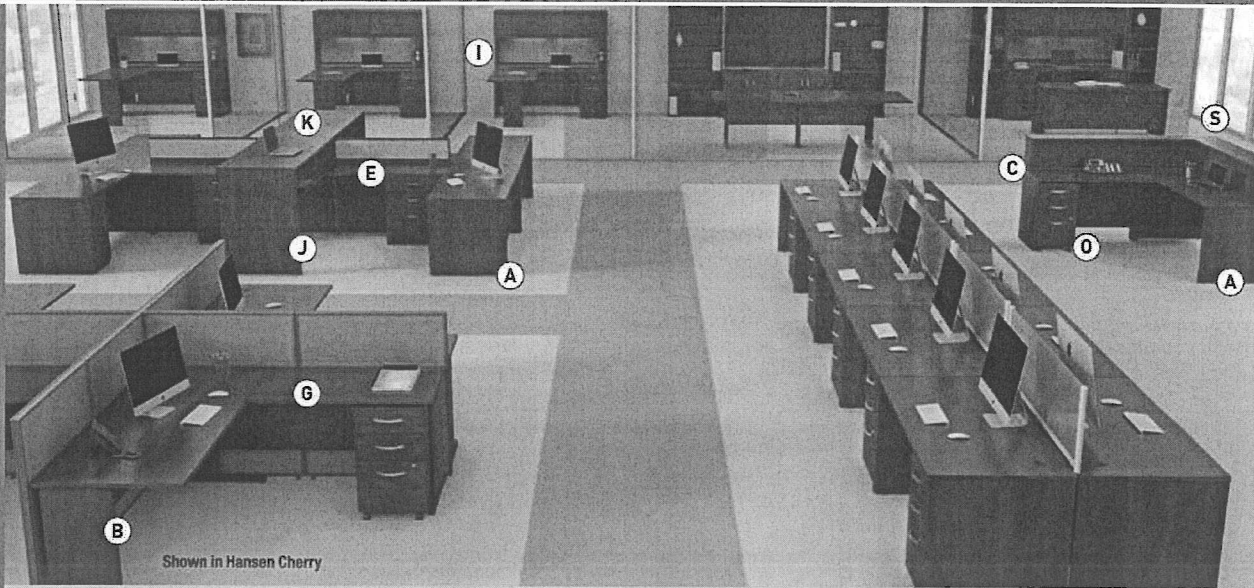

Shown in Hansen Cherry

See page FA63 for Sit-to-Stand desk option.



Series C Elite For the home or professional office, Series C Elite fits your needs with innovative features and design flexibility at a great value.

- Desk design variety with choice of Shell, C-Leg or Table Height formats
- Universal hutches, filing and storage provide 100% compatibility
- Conceal cords and cables with integrated wire management grommets on work surface
- Proven quality constructed of durable, thermally fused laminate for superior resistance to scratches and stains
- Meets ANSI/BIFMA standards for safety and performance
- Commercial quality backed by 10-Year warranty

Available in Mocha Cherry (129) and Hansen Cherry (245) finishes.

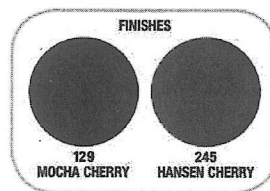

A. Desk Shells

72"W x 36"D Bow Front	LIST PRICE
71"W x 36"D x 30"H	561.00-EA
BSH WC ___46	
72"W x 30"D	
71"W x 30"D x 30"H	499.00-EA
BSH WC ___36	
66"W x 30"D	
66"W x 30"D x 30"H	441.00-EA
BSH WC ___42	
60"W x 36"D Bow Front	
60"W x 36"D x 30"H	520.00-EA
BSH WC ___05	
60"W x 30"D	
60"W x 30"D x 30"H	436.00-EA
BSH WC ___31	

B. C-Leg Desks

72"W x 30"D	466.00-EA
71"W x 29"D x 30"H	
BSH WC ___74	
72"W x 24"D	
71"W x 23"D x 30"H	434.00-EA
BSH WC ___73	
66"W x 30"D	
66"W x 30"D x 30"H	450.00-EA
BSH WC ___67	
60"W x 36"D Bow Front	
60"W x 34"D x 30"H	520.00-EA
BSH WC ___65	

C-Leg Desks continued

60"W x 30"D	
60"W x 30"D x 30"H	BSH WC ___64
60"W x 24"D	
60"W x 23"D x 30"H	BSH WC ___63
48"W x 30"D	
48"W x 30"D x 30"H	BSH WC ___50
48"W x 24"D	
48"W x 23"D x 30"H	BSH WC ___49
36"W x 30"D	
35"W x 30"D x 30"H	BSH WC ___30
36"W x 24"D	
32"W x 23"D x 30"H	BSH WC ___29

C. Desk/Credenza

72"W x 24"D	
71"W x 23"D x 30"H	BSH WC ___26
66"W x 24"D	
66"W x 23"D x 30"H	BSH WC ___69
60"W x 24"D	
60"W x 23"D x 30"H	BSH WC ___61

D. Corner Desk Shells (not shown)

Left: 72"W x 24"D x 36"D	LIST PRICE
71"W x 35"D x 30"H	427.00-EA
BSH WC ___32	
Right: 72"W x 24"D x 36"D	
71"W x 35"D x 30"H	402.00-EA
BSH WC ___23	

E. Bridge

42"W x 24"D	375.00-EA
42"W x 23"D x 21"H	
BSH WC ___43	
42"W x 24"D	343.00-EA

F. Bridge>Returns

48"W x 30"D	
48"W x 24"D x 30"H	BSH WC ___08
	406.00-EA
48"W x 24"D	
48"W x 23"D x 30"H	BSH WC ___24
	272.00-EA
42"W x 24"D	
42"W x 23"D x 30"H	BSH WC ___44
	266.00-EA
30"W x 24"D	
30"W x 23"D x 30"H	BSH WC ___07
	225.00-EA

G. C-Leg Bridge>Returns

42"W x 24"D	
41"W x 23"D x 30"H	BSH WC ___40
	316.00-EA
36"W x 24"D	
35"W x 23"D x 28"H	BSH WC ___35
	205.00-EA

FA56

Available in 10-14 Business days



Additional items available from manufacturer.

Prices subject to change without notice. LA

OFFICE SUITES - Contemporary Laminate



FurnitureAdvantage™

Extended Product Offering



Shown in Mocha Cherry

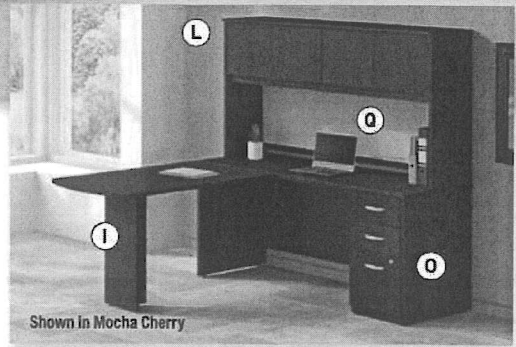

Shown in Mocha Cherry

H. C-Leg Corner Desk (not shown)
 47"W x 47"D x 30"H
 BSH WC___51 LIST PRICE
514.00-EA

I. Peninsulas
 72"W x 30"D
 72"W x 30"D x 30"H
 BSH WC___71 482.00-EA

48"W x 30"D Return
 48"W x 30"D x 30"H
 BSH WC___70 289.00-EA

J. Standing Table Desks
 72"W x 30"D
 72"W x 30"D x 41"H
 BSH WC___75K 749.00-EA

60"W x 24"D
 59½"W x 24"D x 41"H
 BSH WC___15 562.00-EA

K. Standing Desk Shelf Kits
 72"W x 15"D
 68¾"W x 14"D x 11¾"H
 BSH WC___80 332.00-EA

60"W x 12½"D
 57¾"W x 11¾"D x 11¾"H
 BSH WC___16 263.00-EA

L. Hutches
 72"W
 71"W x 15"D x 36"H
 BSH WC___78 687.00-EA

66"W
 65"W x 15"D x 36"H
 BSH WC___68 632.00-EA

60"W
 58"W x 15"D x 36"H
 BSH WC___79 568.00-EA

48"W
 47"W x 15"D x 36"H
 BSH WC___47 498.00-EA

36"W
 35"W x 10"D x 35"H
 BSH WC___37 418.00-EA

Our premier service!
 Product is delivered, unloaded,
 set up, and ready for use in
 the desired home or office
 location. All packaging
 material is removed.
 Contact your sales rep for details.

M. 48W Corner Hutch (not shown)
 47"W x 47"D x 36"H
 BSH WC___45 LIST PRICE
750.00-EA

N. 36W 2-Drawer Pedestals (not shown)
 Assembled.
 24"W
 23"W x 21"D x 30"H
 BSH WC___02SU 621.00-EA

16"W
 16"W x 20"D x 29"H
 BSH WC___56SU 498.00-EA

O. 3-Drawer Pedestals Assembled.
 24"W
 23"W x 21"D x 30"H
 BSH WC___01SU 643.00-EA

16"W
 16"W x 20"D x 29"H
 BSH WC___55SU 614.00-EA

P. 36W 2-Drawer Lateral File (not shown)
 Assembled.
 36"W x 23"D x 30"H
 BSH WC___54CSU 755.00-EA

Q. Tackboards Lyric Sundew fabric.
 72"W
 68"W x ½"D x 16"H
 BSH WCTB72LS LIST PRICE
155.00-EA

66"W
 62"W x ½"D x 16"H
 BSH WCTB66LS 145.00-EA

60"W
 56"W x ½"D x 16"H
 BSH WCTB60LS 134.00-EA

48"W
 44"W x ½"D x 16"H
 BSH WCTB48LS 113.00-EA

36"W
 33"W x ½"D x 16"H
 BSH WCTB36LS 101.00-EA

R. 60W Desk Top Organizer
 45"W x 13"D x 14"H
 BSH WC___10 295.00-EA

S. Reception L-Shelf
 77"W x 71"D x 14"H
 BSH WC___76 499.00-EA

Assembly needed.
 Please call for details.
 † Cannot be shipped UPS.
 †† Cannot be shipped UPS Air. LA



Additional items available
 from manufacturer.

Available in 10-14
 Business days

FA57



OFFICE SUITES - Contemporary Laminate

Furniture Advantage™

Extended Product Offering



Shown in Light Oak



Our premier service!
Product is delivered, unloaded,
set up, and ready for use in
the desired home or office
location. All packaging
material is removed.

Contact your sales rep for details.



Series C

- Classic styling with clean lines and extended modesty panels for modular workspace configurations. Ideal for closed offices, reception areas, conference rooms and work at home professionals.
- Thermally fused laminate work surfaces feature superior resistance to scratches and stains
- Quick installation with pre-assembled pedestal and lateral files
- Durable PVC edge banding on work surface resists collisions and dents
- Full-extension ball bearing drawer slides on file drawers accommodate letter and legal files
- Integrated wire management and self-closing euro-style hinges
- Meets ANSI/BIFMA standards for safety and performance
- Commercial quality backed by 10-Year Warranty

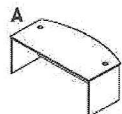
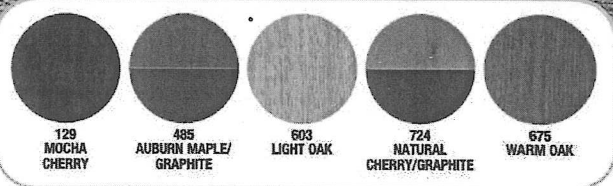

A. Bow Front Desk Shells (not shown)

71"W x 36"D x 30"H
BSH WC ___ 46

LIST PRICE
661.00-EA

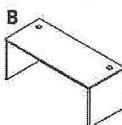

B. Desks

72" Rectangular
71"W x 30"D x 30"H
BSH WC ___ 36
66" Rectangular (not shown)
66"W x 36"D x 30"H
BSH WC ___ 42A

499.00-EA

441.00-EA



C. Right Corner Modules (not shown)

71"W x 35"D x 30"H
BSH WC ___ 23

LIST PRICE
666.00-EA

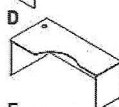

D. Left Corner Modules (not shown)

71"W x 35"D x 30"H
BSH WC ___ 32

666.00-EA

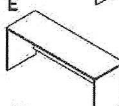

E. Credenza Shells

71"W x 23"D x 30"H
BSH WC ___ 26
60"W x 23"D x 30"H
BSH WC ___ 61

467.00-EA

406.00-EA

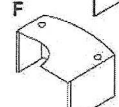

F. Right L-Bow Desks

58 1/2"W x 42 1/2"D x 29 1/2"H
BSH WC ___ 22

616.00-EA

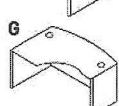

G. Left L-Bow Desks (not shown)

58 1/2"W x 42 1/2"D x 29 1/2"H
BSH WC ___ 33

616.00-EA

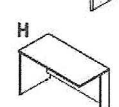

H. Return Bridges Non-Handed

48"W x 23"D x 30"H
BSH WC ___ 24
35 1/2"W x 23 1/2"D x 29 1/2"H (not shown)
BSH WC ___ 18

272.00-EA

226.00-EA



Additional items available
from manufacturer.

Prices subject to change
without notice. LA

FA58

Available in 10-14
Business days

OFFICE SUITES - Contemporary Laminate



Shown in Mocha Cherry

Furniture Advantage™ Extended Product Offering



I. Reception L-Hutch (not shown)
 Attaches to 72" Desk with 48" Return Bridges.
 77"W x 71"D x 14"H
 BSH WC ___76

LIST PRICE
499.00-EA



J. 4-Door 72W Hutch (not shown)
 71"W x 15"D x 43"H
 BSH WC ___77

764.00-EA



K. 2-Door 72W Hutch
 71"W x 15"D x 43"H
 BSH WC ___66

764.00-EA



L. 60W Hutch
 58"W x 15"D x 43"H
 BSH WC ___62

639.00-EA



M. 3-Drawer Box/Box/File Mobile Pedestals (not shown)
 15"W x 20"D x 27"H
 BSH WC ___53SU

499.00-EA



N. 2-Drawer File/File Mobile Pedestals
 15"W x 20"D x 27"H
 BSH WC ___52SU

469.00-EA



O. 3/4 Box/File Pedestals (not shown)
 15"W x 20"D x 20"H
 BSH WC ___90SU

397.00-EA



P. 2-Drawer Lateral Files
 Interlocking drawer mechanism prevents tipping.
 35"W x 23"D x 29"H
 BSH WC ___54ASU

755.00-EA



Q. Storage Cabinets
 Accepts 30" Hutch.
 29"W x 23"D x 29"H
 BSH WC ___96A

LIST PRICE
405.00-EA



R. Storage Cabinets (not shown)
 Accepts 24" Hutch.
 23"W x 23"D x 29"H
 BSH WC ___04

624.00-EA



S. Hutches
 Mounts on 30" Storage Cabinet.
 29"W x 15"D x 43"H
 BSH WC ___97

405.00-EA



T. Hutches (not shown)
 Mounts on 24" Storage Cabinet.
 23"W x 15"D x 43"H
 BSH WC ___06

462.00-EA



U. Open Double Bookcases (not shown)
 35"W x 15"D x 72"H
 BSH WC ___14

404.00-EA

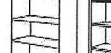

V. Open Single Bookcases
 17"W x 15"D x 72"H
 BSH WC ___12

297.00-EA



W. Half Height Door Kits, 2-Doors (not shown)
 For use with item "U".
 35"W x 29"H
 BSH WC ___11

125.00-EA



X. Mobile Tables (not shown)
 35"W x 22"D x 26"-34"H
 BSH WC ___82

455.00-EA

Assembly needed. Please call for details.
 Cannot be shipped UPS.
 Cannot be shipped UPS Air. LA



Additional items available from manufacturer.

Available in 10-14 Business days

FA59



OFFICE SUITES - Contemporary Laminate

FurnitureAdvantage™

Extended Product Offering

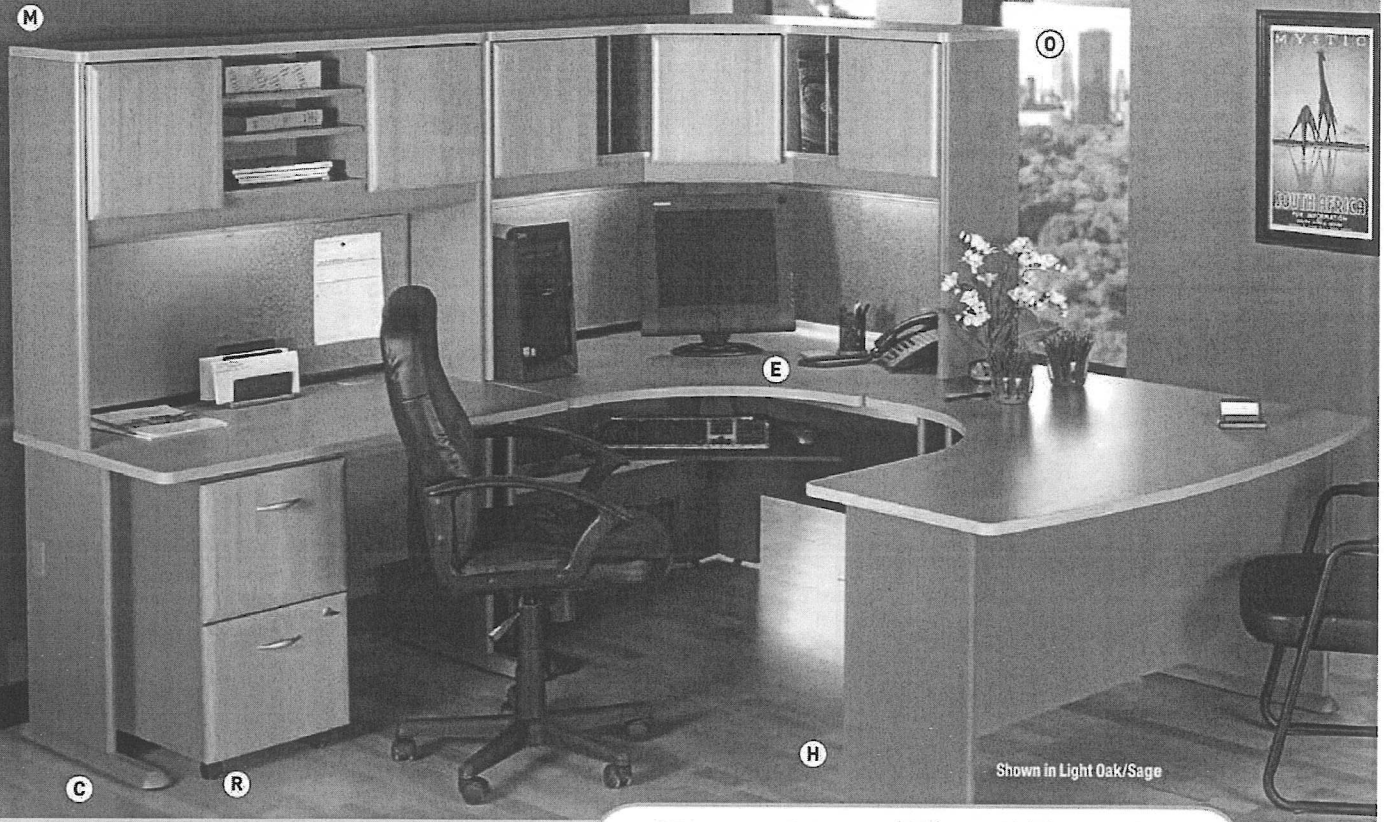

Shown in Light Oak/Sage



Series A Open leg table design provides flexible solutions for easy workspace configurations. Ideal for open space offices, cubicles, multi-person workstations and small space solutions.

- Thermally fused laminate work surfaces feature superior resistance to scratches and stains
- Quick installation with pre-assembled pedestal and lateral files
- Durable PVC edge banding on work surface resists collisions and dents
- Full-extension ball bearing drawer slides on file drawers accommodate letter and legal files
- Integrated wire management and self-closing euro-style hinges
- Meets ANSI/BIFMA standards for safety and performance
- Commercial quality backed by 10-Year Warranty

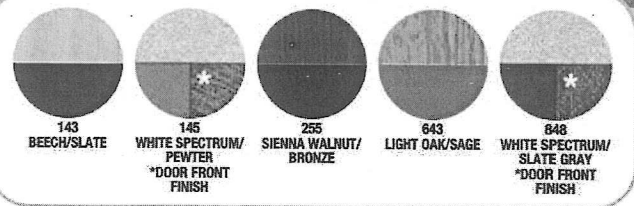

- A. 72W Rectangular Desk (not shown)** **LIST PRICE 648.00-EA**
 71 1/2"W x 26 1/4"D x 29 1/2"H
 BSH WC ___72
- B. 60W Rectangular Desk (not shown)** **467.00-EA**
 59 1/2"W x 26 1/4"D x 29 1/2"H
 BSH WC ___60
 BSH WC8460A White Spectrum/Slate Only **467.00-EA**
- C. 48W Rectangular Desk** **398.00-EA**
 47 1/2"W x 26 1/4"D x 29 1/2"H
 BSH WC ___48
 BSH WC8448A White Spectrum/Slate Only **398.00-EA**
- D. 36W Rectangular Desk** **267.00-EA**
 35 1/2"W x 26 1/4"D x 29 1/2"H
 BSH WC ___36
 BSH WC8436A White Spectrum/Slate Only **267.00-EA**

- E. 48W Corner Desk** **499.00-EA**
 Use as a stand alone unit or add a desk at either side to form efficient "L" configuration.
 47 1/2"W x 47 1/2"D x 29 1/2"H
 BSH WC ___66
 BSH WC8427A White Spectrum/Slate Only **499.00-EA**
- F. 42W Corner Desk (not shown)** **428.00-EA**
 41 1/2"W x 41 1/2"D x 29 1/2"H
 BSH WC ___42
- G. Right L-Bow Desk (not shown)** **516.00-EA**
 59 1/2"W x 43 1/2"D x 29 1/2"H
 BSH WC ___22
- H. Left L-Bow Desk** **616.00-EA**
 59 1/2"W x 43 1/2"D x 29 1/2"H
 BSH WC ___33
- I. Peninsula (not shown)** **430.00-EA**
 Attaches to right or left side of rectangular desks. Freestanding.
 71 1/2"W x 26 1/4"D x 29 1/2"H
 BSH WC ___71
 BSH WC8435 White Spectrum/Slate Only **430.00-EA**

FA60

Available in 10-14 Business days



Additional items available from manufacturer.

Prices subject to change without notice. LA

OFFICE SUITES - Contemporary Laminate



Furniture Advantage™
Extended Product Offering

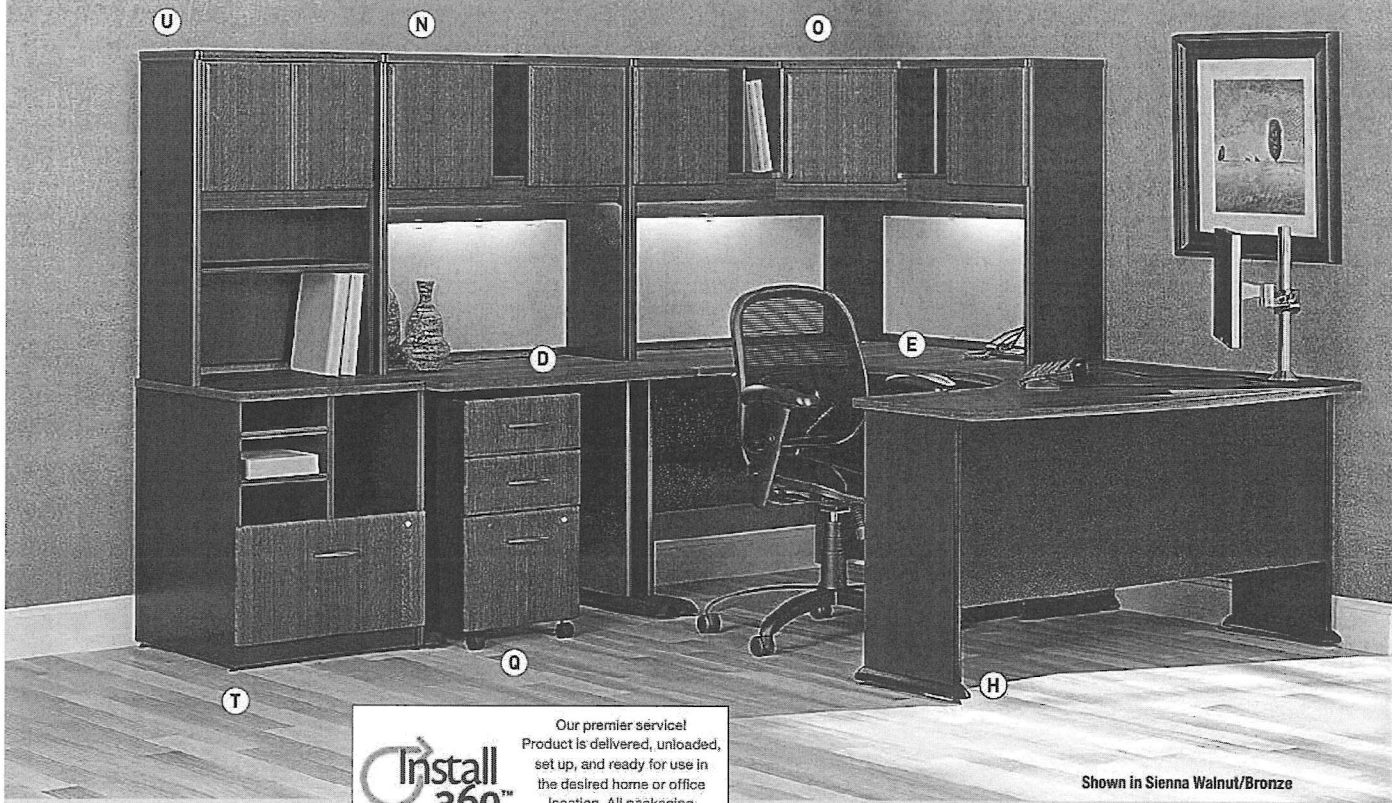

Shown in Sienna Walnut/Bronze

Install 360™

Our premier service! Product is delivered, unloaded, set up, and ready for use in the desired home or office location. All packaging material is removed.

Contact your sales rep for details.

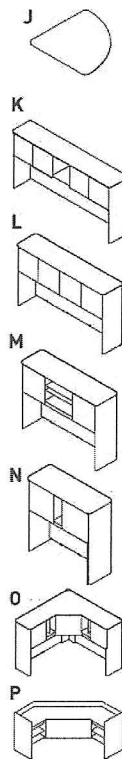

J. Corner Connector (not shown) Connect two desks or desk and peninsula into single "L"-shape configurations.
26"W x 26"D x 1"H
BSH WC ___ 29
BSH WC8426 White Spectrum/Slate Only

Hutches Full-width tack board on back panels except on 42" Corner Hutch.

K. 72W Hutch (not shown)
71"W x 13"D x 36"H
BSH WC ___ 73 997.00-EA

L. 60W Hutch (not shown)
59"W x 13"D x 36"H
BSH WC ___ 61 883.00-EA

M. 48W Hutch
47"W x 13"D x 36"H
BSH WC ___ 49 632.00-EA

N. 36W Hutch
35"W x 13"D x 36"H
BSH WC ___ 37 499.00-EA

O. 48W Corner Hutch
For use with Corner Desk (E).
47"W x 47"D x 36"H
BSH WC ___ 67 944.00-EA

P. 42W Corner Hutch (not shown)
For use with Corner Desk (F).
40"W x 40"D x 23"H
BSH WC ___ 43 609.00-EA

Q. 3-Drawer Mobile Pedestal File
15"W x 20"D x 27"H
BSH WC ___ 53SU LIST PRICE 509.00-EA

R. 2-Drawer Mobile Pedestal File
15"W x 20"D x 27"H
BSH WC ___ 52SU 493.00-EA

S. Lateral File (not shown)
Accommodates letter- or legal-size files.
35"W x 23"D x 29"H
BSH WC ___ 54ASU 788.00-EA

T. 24W Storage Unit
23"W x 23"D x 29"H
BSH WC ___ 23 621.00-EA

U. 24W Storage Hutch
23"W x 13"D x 36"H
BSH WC ___ 25 396.00-EA

V. 5-Shelf Bookcase (not shown)
25"W x 13"D x 66"H
BSH WC ___ 65 329.00-EA

W. Vertical Locker (not shown)
16"W x 20"D x 66"H
BSH WC ___ 75SU‡ 939.00-EA

Assembly needed. Please call for details.
‡Cannot be shipped UPS.
‡‡Cannot be shipped UPS Air. LA

Additional items available from manufacturer.

Available in 10-14 Business days **FA61**



OFFICE SUITES - Contemporary Laminate

Furniture Advantage™

Extended Product Offering



300 Series

- Durable, thermally fused laminate work surfaces feature superior resistance to scratches and stains
- Durable PVC edge banding on work surface resists collisions and dents
- Full-extension ball-bearing drawer slides on file drawers
- Meets ANSI/BIFMA standards for safety and performance
- Commercial quality backed by Limited Lifetime Warranty

Available in Natural Maple (AC) and Mocha Cherry (MR) finishes.

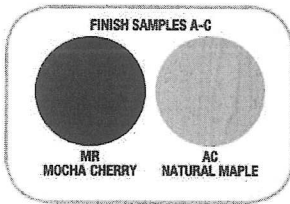

Our premier service! Product is delivered, unloaded, set up, and ready for use in the desired home or office location. All packaging material is removed.

Install 360™

Contact your sales rep for details.

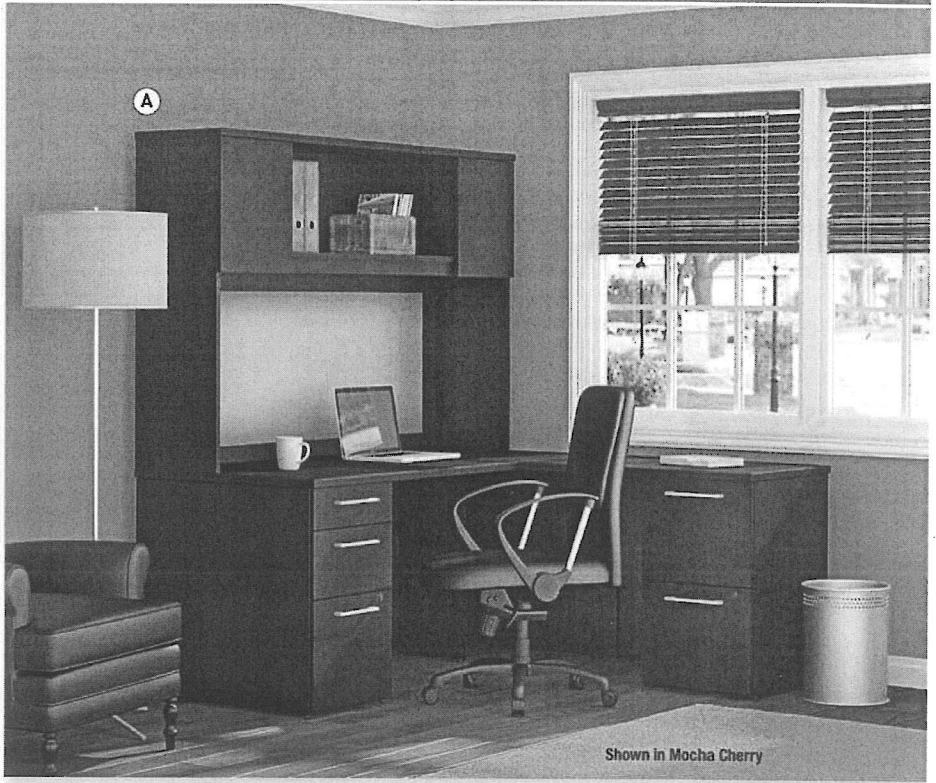

A. L-Desk With Storage, Pedestals & Hutch 66W x 30D Single Pedestal Desk with 36W Return and Hutch. Dimensions are for complete configuration.

65 1/2"W x 65 1/2"D x 72"H
BSH 300S040__

LIST PRICE
2996.00-EA



B. 60W x 22D Single Pedestal L-Desk (not shown)

With three drawer pedestal.

59 1/2"W x 57 1/2"D x 29 1/2"H
BSH 300S038__

LIST PRICE
1776.00-EA

C. Desk - U-Configuration

With two and three drawer pedestals.

71 1/2"W x 93"D x 29 1/2"H
BSH 300S030__

LIST PRICE
2776.00-EA

FA62

Available in 10-14 Business days



Additional items available from manufacturer.

Prices subject to change without notice. LA

OFFICE SUITES - Sit-To-Stand



Shown in Mocha Cherry



Height Adjustable Standing Desks Height adjustable tables provide a flexible, healthy and ergonomic solution for today's work environments.

- Four programmable memory presets with a quiet, soft touch start and stop
- Three stage units provide wider height range from 23"-49"H and operates at speed of 1½" per second
- Quiet UL listed electric motors, 10' power cord plugs into standard wall outlet
- Works well in both open plan and private office settings, can be used as a table, return or bridge
- Integrates easily with other Bush Business Furniture products for a complete cohesive environment
- Durable thermally fused laminate work surfaces feature superior resistance to scratches and stains
- Meets ANSI/BIFMA standards for safety and performance

See pages FA56-FA57 for coordinating Series C Elite items.

Available in Hansen Cherry (HC), Natural Cherry (NC), Mocha Cherry Satin (MRS) and Mocha Cherry (MR) finishes.

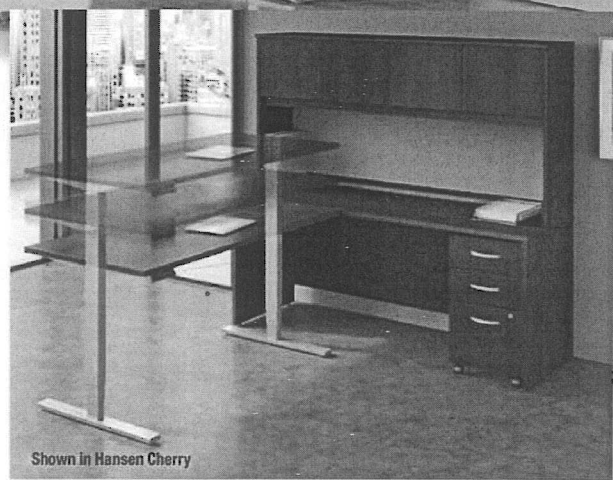

Shown in Hansen Cherry

Install
360™

Our premier service! Product is delivered, unloaded, set up, and ready for use in the desired home or office location. All packaging material is removed.

Contact your sales rep for details.

A. 72W x 30D x 23H Tables

		LIST PRICE
BSH HAT7230__BK	Black Base	1749.00 EA
BSH HAT7230__K	Gray Base	1749.00 EA

B. 60W x 30D x 23H Tables

BSH HAT6030__BK	Black Base	1661.00 EA
BSH HAT6030__K	Gray Base	1661.00 EA

C. 48W x 30D x 23H Tables

BSH HAT4830__BK	Black Base	1632.00 EA
BSH HAT4830__K	Gray Base	1632.00 EA

D. 48W x 24D x 23H Tables

BSH HAT4824__BK	Black Base	1617.00 EA
BSH HAT4824__K	Gray Base	1617.00 EA

FINISHES

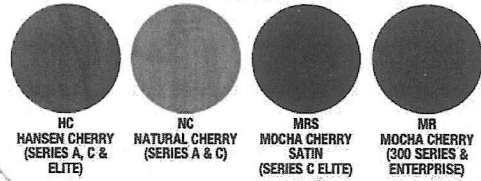

Assembly needed.
Please call for details.

‡ Cannot be shipped UPS.

‡‡ Cannot be shipped UPS Air. LA



Additional items available
from manufacturer.

Available in 10-14
Business days

FA63



OFFICE SUITES - Sit-To-Stand

Furniture Advantage™

Extended Product Offering



Black Base/
Hardrock Maple Top



Silver Base/Cherry Top

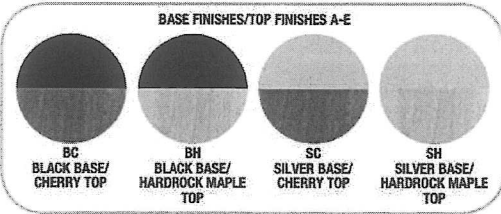

Available in Black/Cherry (BC), Black/Hardrock Maple (BH), Silver/Cherry (SC), and Silver/Hardrock Maple (SH)



Black Base/Cherry Top

CARB
Compliant

E. HV-Series Built-In Hover Vertical

- All-in-one furniture solution for spaces that require flexibility
- Built-in Hover vertical gas assisted monitor lift
- Single or double units with independently controlled lifts
- Houses up to 22" monitor
- Built-in keyboard and mouse storage
- Available with locking option
- Wire management available
- CARB compliant
- Contains 60% recycled content

72" x 24", Double Lift RAA HV2472WS_ _ ‡	LIST PRICE 2887.00- EA
36" x 24", Single Lift RAA HV2436WS_ _ ‡	1548.00- EA

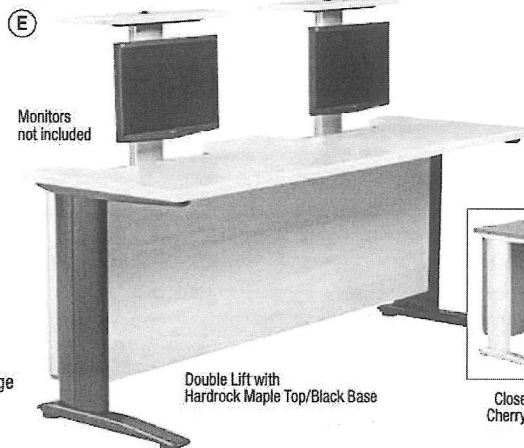

Double Lift with
Hardrock Maple Top/Black Base

Closed Position with
Cherry Top/Silver Base



Single Lift with
Cherry Top/Silver Base

F. Flex Cable Management

Removable links offer custom fit. Weighted low-profile base. 51"L. For use with Elegante XT and Eficiente LT Series above.

RAA FCM490	LIST PRICE 72.00- EA
------------	------------------------------------

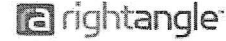
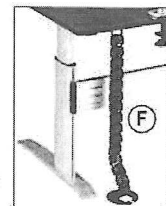

Elegante XT Series – Electric Height-Adjustable Workstations Push button controlled for easy height adjustment. 1½" per second adjustment speed. Height range 24"-51"H. 4-Outlet/2 USB port power strip included. Programmable switch available. 10/5-year warranty.

A. Height-Adjustable Workstations

Lifting capacity up to 325 lbs. Includes 4EVERedge seam free edge banding.	
72"W x 24"D x 24"-51"H RAA NXTAAS2472_ _ ‡	LIST PRICE 2585.00- EA
60"W x 24"D x 24"-51"H RAA NXTAAS2460_ _	2673.00- EA
48"W x 24"D x 24"-51"H RAA NXTAAS2448_ _	2486.00- EA
36"W x 24"D x 24"-51"H RAA NXTAAS2436_ _	2388.00- EA

B. Height-Adjustable L Workstation With 3 Lift Column

Lifting capacity up to 450 lbs.	
60"W x 60"W x 24"D x 27"-47"H RAA NXTAGS2460_ _ ‡	4282.00- EA

Eficiente LT Series – Electric Height-Adjustable Workstations

Push button controlled for easy height adjustment. 1½" per second adjustment speed. Height range: 27"-47"H. 10/5-year warranty.

C. Height-Adjustable Workstations

Total lifting capacity base only: 250 lbs. 2-leg. Includes 4EVERedge seam free edge banding.	
72"W x 24"D x 27"-47"H RAA NLTAS2472_ _ ‡	LIST PRICE 1986.00- EA
60"W x 24"D x 27"-47"H RAA NLTAS2460_ _	1932.00- EA
48"W x 24"D x 27"-47"H RAA NLTAS2448_ _	1855.00- EA
36"W x 24"D x 27"-47"H RAA NLTAS2436_ _	1758.00- EA

D. Height-Adjustable L Workstation With 3 Lift Column (not shown)

Total lifting capacity base only: 375 lbs. 3-leg.	
60"W x 60"W x 24"D x 27"-47"H RAA NLTAGS2460_ _ ‡	3366.00- EA

FA64

Available in 10-14 Business days



Additional items available from manufacturer.

Prices subject to change without notice. LA

OFFICE SUITES - Sit-to-Stand

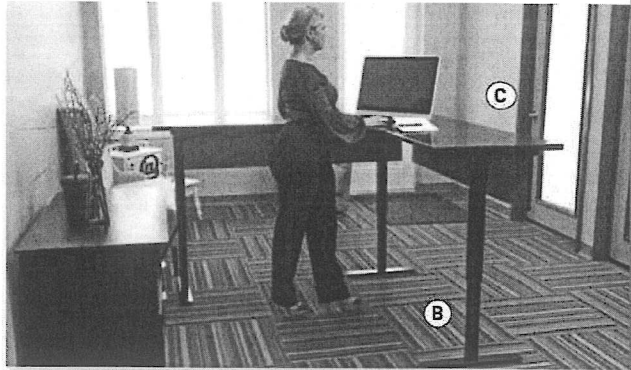
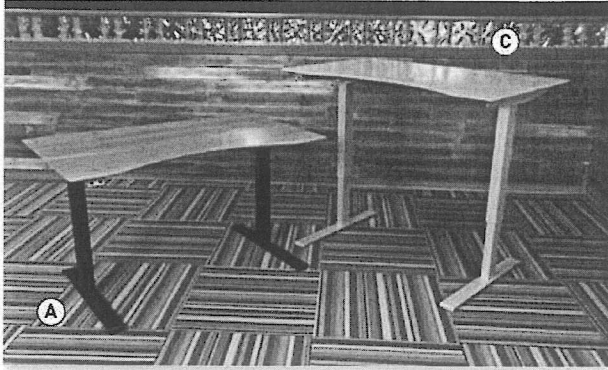

frösch
powered by SWEDISTYLE

NEW!

A. Aero Sit/Stand Height Adjustable Frame

- Flex+width accommodates 42"-80" table tops
- 2D (2-stage) 26½" - 46¼"
- 3D (3-stage) 23½" - 49½"
- 275 lbs. lift capacity
- Dual motor, comes with up/down controller
- Built-in collision safety sensor
- **Tops sold separately**

2-Stage

41"W x 27½"D x 26½"-46¼"H		LIST PRICE
FCH SWD6326	Black	1200.00-EA
FCH SWD6005	White	1200.00-EA
FCH SWD6333	Silver	1200.00-EA

3-Stage

41"W x 27½"D x 23½"-49½"H		LIST PRICE
FCH SWD6340	Black	1400.00-EA
FCH SWD6357	Silver	1400.00-EA
FCH SWD6012	White	1400.00-EA

D. Upgraded Memory Hand Controller (not shown)

- 4-button memory settings
 - Digital height display
 - Retractable low profile design
- | | | |
|-----------------|-------|-------------------|
| 5"W x 5"D x ½"H | | LIST PRICE |
| FCH SWD6067 | Black | 105.00-EA |

B. Aero Sit/Stand Height Adjustable 3rd Leg Frame

- 2-Leg Frame 330 lbs. lift capacity
- **Tops sold separately**

2-Stage

41"W x 41"D x 26½"-46¼"H		LIST PRICE
FCH SWD6203	Black	940.00-EA
FCH SWD6227	White	940.00-EA
FCH SWD6210	Silver	940.00-EA

3-Stage

41"W x 41"D x 23½"-49½"H		LIST PRICE
FCH SWD6234	Black	1035.00-EA
FCH SWD6241	Silver	1035.00-EA
FCH SWD6258	White	1035.00-EA

E. Wireform Cable Tray With Panel Mount Kit (not shown)

- Accommodates 60" and 72" table tops
- Manages cables and provides easy access
- Includes panel mounting hardware

55"W x 6"D x 6"H		LIST PRICE
FCH FRS6098	White	82.00-EA
FCH FRS6050	Black	82.00-EA
FCH FRS6621	Silver	82.00-EA

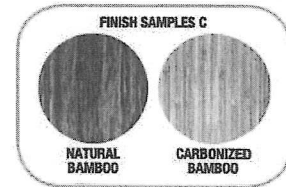

C. Natural Solid Wood Bamboo Desk Top

- Stranded bamboo desk top
- Reverse knife edge
- Wire access slot
- Cockpit curve
- **Frames sold separately**

For 2-Leg Frame

72"W x 30"W		LIST PRICE
FCH FRS6302‡	Natural Bamboo	520.00-EA
FCH FRS6319‡	Carbonized Bamboo	520.00-EA
60"W x 30"D		
FCH FRS6289‡	Natural Bamboo	445.00-EA
FCH FRS6296‡	Carbonized Bamboo	445.00-EA
48"W x 30"D		
FCH FRS6272	Carbonized Bamboo	395.00-EA
FCH FRS6265	Natural Bamboo	395.00-EA

For 3-Leg Frame

72"W x 24"D		LIST PRICE
FCH FRS6807‡	Carbonized Bamboo	865.00-EA
FCH FRS6791‡	Natural Bamboo	865.00-EA

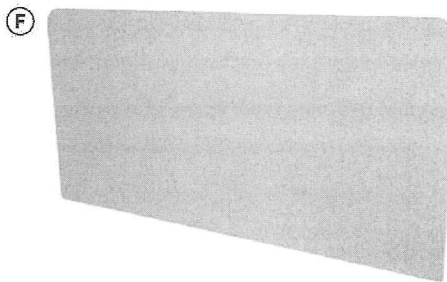

F. Tack-able 2-Sided Cork Back Panel

- Edge band matches frame color
- Custom graphic outer fabric also available

Full-Size 24" Tall

72"W x 24"D x 1"H		LIST PRICE
FCH FRS6388‡	Natural Cork	310.00-EA
60"W x 24"D x 1"H		
FCH FRS6371‡	Natural Cork	270.00-EA
48"W x 24"D x 1"H		
FCH FRS6364	Natural Cork	220.00-EA

Half-Size 12" Tall

72"W x 12"D x 1"H		LIST PRICE
FCH FRS6432‡	Natural Cork	190.00-EA
60"W x 12"D x 1"H		
FCH FRS6418‡	Natural Cork	177.00-EA
48"W x 12"D x 1"H		
FCH FRS6395	Natural Cork	155.00-EA

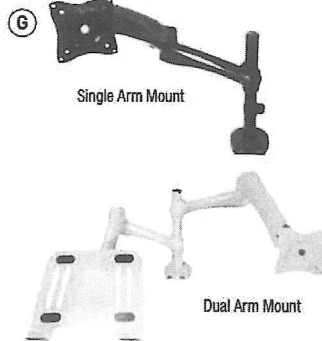

G. VESA Monitor Mount

- Single arm fully adjustable and articulating
- Two USB ports located at base for charging and connecting electronic devices
- Gas spring counter-balance arms, 19.8 lb. rated

Single Arm Monitor Mount

20"W x 20"D x 12"H		LIST PRICE
FCH FRS6029		195.00-EA
FCH FRS6128		195.00-EA

Dual Arm Monitor Mount

40"W x 20"D x 12"H		LIST PRICE
FCH FRS6036		280.00-EA
FCH FRS6043		280.00-EA

H. Metal Storage Drawer With Lock (not shown)

- Contoured design with lock
- Accommodates most laptop sizes

15"W x 14"D x 3"H		LIST PRICE
FCH FRS6142	Black	110.00-EA
FCH FRS6135	White	110.00-EA

Assembly needed. Please call for details.

‡Cannot be shipped UPS.
‡‡Cannot be shipped UPS Air. LA



Additional items available from manufacturer.

Available in 10-14 Business days

FA65

Furniture Advantage™

Extended Product Offering



OFFICE SUITES - Sit-To-Stand

Furniture Advantage™

Extended Product Offering

SPECIAL T

NEW!

ValuLift Height-Adjustable Tables

- Electric height ranges between 25½" - 51"H
- Crank height ranges between 27½" - 45"H
- Built-in adjustable top support
- Four turns per load
- Max base load of 220 lbs.
- 5-years parts and labor warranty

Basic electric base is available in Black (BLK), Silver (SLV) or White (WHT) finish. Crank base is available in Silver finish. Tops are available in Mahogany (MHG), Cherry (CH), Light Gray (GR), Espresso (ESP), White (WHT) or Burnished Teak (BT) finishes.

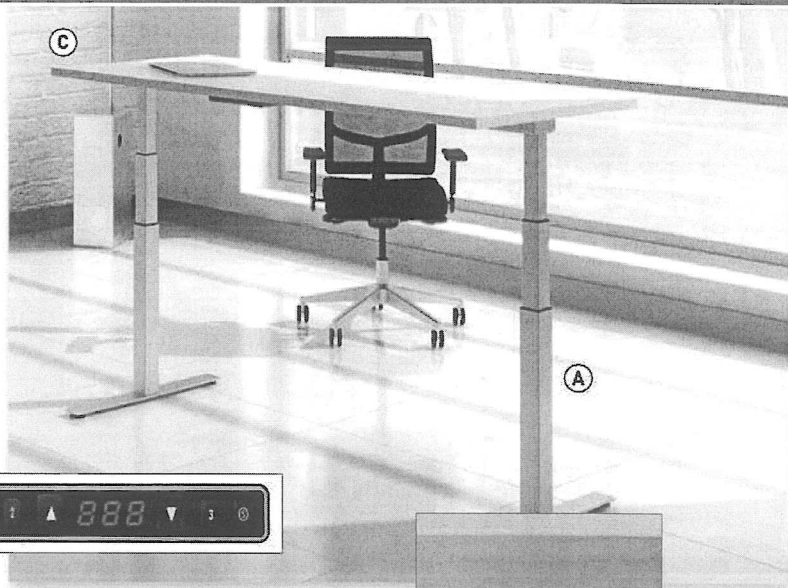

A. Electric Height-Adjustable Base Includes two bases, control box, cables, and control buttons.
 72"W x 24"D x 25"-51"H LIST PRICE 996.00-~~EA~~
 SCT VALUB ___ ‡

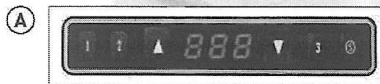

B. Crank Height-Adjustable Base Available in Silver finish as shown.
 48"-72"W x 24"D x 26"-43½"H 840.00-~~EA~~
 SCT CRANKBSLV ‡



C. Laminate Table Tops Matching PVC edge.
 72"W x 24"D x 29"H 370.00-~~EA~~
 SCT 01RT2472 ___ ‡
 60"W x 24"D x 29"H 315.00-~~EA~~
 SCT 01RT2460 ___ ‡
 48"W x 24"D x 29"H 288.00-~~EA~~
 SCT 01RT2448 ___ ‡



D. Treadmill For ValuLift Table *Available with extended lead time 4-6 weeks.
 63"W x 28½"D x 7¾"H LIST PRICE 3172.00-~~EA~~
 SCT TREADMILL3 ‡

rightangle

Elegante XT Series - Electric Height-Adjustable
 Push button controlled for easy height adjustment. 1½" per second adjustment speed. Height range 24"-51"H. Includes 4EVERedge, seam free edge banding.

E. Height-Adjustable Workstations Lifting capacity up to 325 lbs. 10/5-year warranty. 4-outlet/2 USB port power strip included. Programmable switch available.
 72"W x 24"D x 24"-51"H LIST PRICE 2595.00-~~EA~~
 RAA NXTAAS2472 ___ ‡
 60"W x 24"D x 24"-51"H 2573.00-~~EA~~
 RAA NXTAAS2460 ___ ‡
 48"W x 24"D x 24"-51"H 2496.00-~~EA~~
 RAA NXTAAS2448 ___ ‡
 36"W x 24"D x 24"-51"H 2398.00-~~EA~~
 RAA NXTAAS2436 ___ ‡

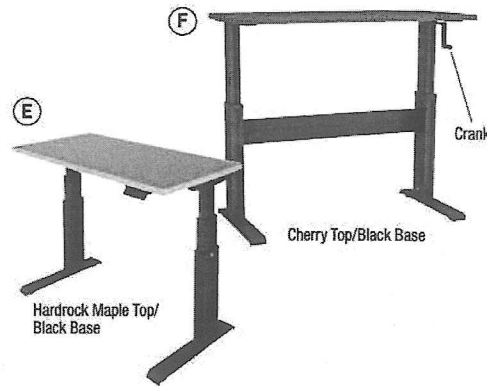
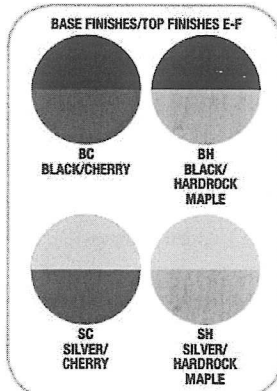

F. Vuelta Crank Height-Adjustable Table Crank (with worksurface). Lifting capacity 250 lbs./125 lbs. per lifting column. Height range 27"-47"H. Includes 4EVERedge, seam free edge banding. 10-year warranty.
 72"W x 24"D x 27"-47"H 1912.00-~~EA~~
 RAA NCRAAS2472 ___ ‡
 60"W x 24"D x 27"-47"H 1857.00-~~EA~~
 RAA NCRAAS2460 ___ ‡
 48"W x 24"D x 27"-47"H 1780.00-~~EA~~
 RAA NCRAAS2448 ___ ‡
 36"W x 24"D x 27"-47"H 1683.00-~~EA~~
 RAA NCRAAS2436 ___ ‡

Available in Black Base/Cherry Finish (BC), Black Base/Hardrock Maple Finish (BH), Silver Base/Cherry Finish (SC) and Silver Base/Hardrock Maple Finish (SH).

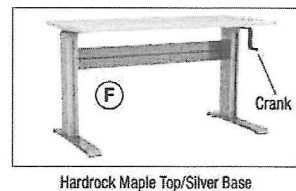

FA66

Available in 10-14 Business days



Additional items available from manufacturer.

Prices subject to change without notice. LA

OFFICE SUITES - Sit-To-Stand



FurnitureAdvantage™

Extended Product Offering



Ascend Adjustable-Height Table/Desk Series

- Provide workers with opportunity to sit and stand for flexibility throughout the workday
- Choose dual-cylinder Pneumatic bases or dual-motor Electric bases, both with synchronized design for smooth, long-lasting operation regardless of weight distribution
- Both include adjustable leveling glides
- Pneumatic bases also include casters for use as collaborative tables in open office settings
- Meets BIFMA standards

Available in Black Top/Black Base (BB), Black Top/Silver Base (BS), Black Top/White Base (BW), Cherry Top/Black Base (CB), Cherry Top/Silver Base (CS), Cherry Top/White Base (CW), Espresso Top/Black Base (EB), Espresso Top/Silver Base (ES), Espresso Top/White Base (EW), White Top/Black Base (WB), White Top/Silver Base (WS) and White Top/White Base (WW).

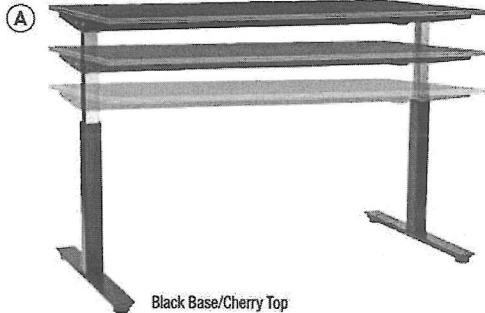
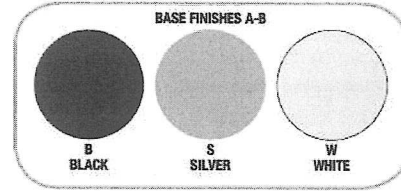
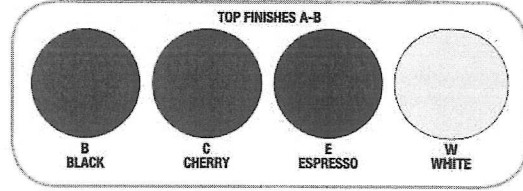

Black Base/Cherry Top

A. Electric Series

- 26" height adjustment range from 25" to 51"
- Meets BIFMA standards
- Meets UL & CAN/CSA electrical standards
- Active weight capacity 250 lbs.
- Stationary weight capacity 250 lbs.

	LIST PRICE
60"W x 30"D OSP ASE3060_ _ ‡	2415.00-EA
60"W x 24"D OSP ASE2460_ _ ‡	2375.00-EA
48"W x 24"D OSP ASE2448_ _ ‡	2325.00-EA

B. Ascend 4-Position Electrical Control (not shown) Optional 4-position memory control

OSP AE3P ‡	130.00-EA
------------	-----------

MAYLINE

2-Stage Height-Adjustable Tables

- 2 stage base offered in a 2 leg model
- Drive System: 110V, 60Hz AC input 120V DC motor – draws a maximum of 3 amps
- Travel Range: 19 3/8" of vertical adjustment from 28" to 47 3/8" (with feet and worksurface)
- Adjustment Speed: 3/4" per second
- Simple up/down control switch sold as standard
- LED 3 position preset control available as an accessory option
- Load capacity: 220 lbs. evenly distributed

Available in Designer White with Silver finish base.

D. Tables (Top & Base)

	LIST PRICE
72"W x 30"D x 28"-47 3/8"H MLN 5223072HSDSW ‡	1725.00-EA
60"W x 30"D x 28"-47 3/8"H MLN 5223060HSDSW ‡	1615.00-EA
48"W x 30"D x 28"-47 3/8"H MLN 5223048HSDSW ‡	1465.00-EA

Assembly needed. Please call for details.
‡Cannot be shipped UPS.
‡‡Cannot be shipped UPS Air. LA



Additional items available from manufacturer.

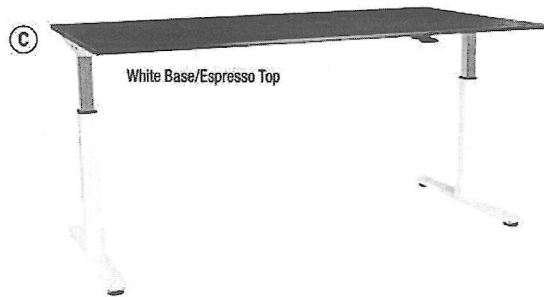

White Base/Espresso Top

C. Pneumatic Series

- 13 1/2" height adjustment range
- With glides installed, table height adjusts to 26 3/4" to 40 1/4"
- With casters installed, table height adjusts to 29 3/4" to 43 1/4"
- Active weight capacity 50 lbs.

	LIST PRICE
72"W x 36"D OSP ASP3672_ _ ‡	1675.00-EA
60"W x 30"D OSP ASP3060_ _ ‡	1465.00-EA
60"W x 24"D OSP ASP2460_ _ ‡	1385.00-EA
48"W x 24"D OSP ASP2448_ _ ‡	1310.00-EA



D

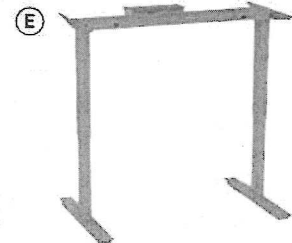

E

E. Table Base Only Base Only adjusts to accommodate any surface 48" - 72"

48"-72"W x 26"D x 26 1/2"-46 1/2"H MLN 52230S	LIST PRICE 1420.00-EA
--	--------------------------

Available in 10-14 Business days

FA67



OFFICE SUITES - Steel Desks

FurnitureAdvantage™

Extended Product Offering

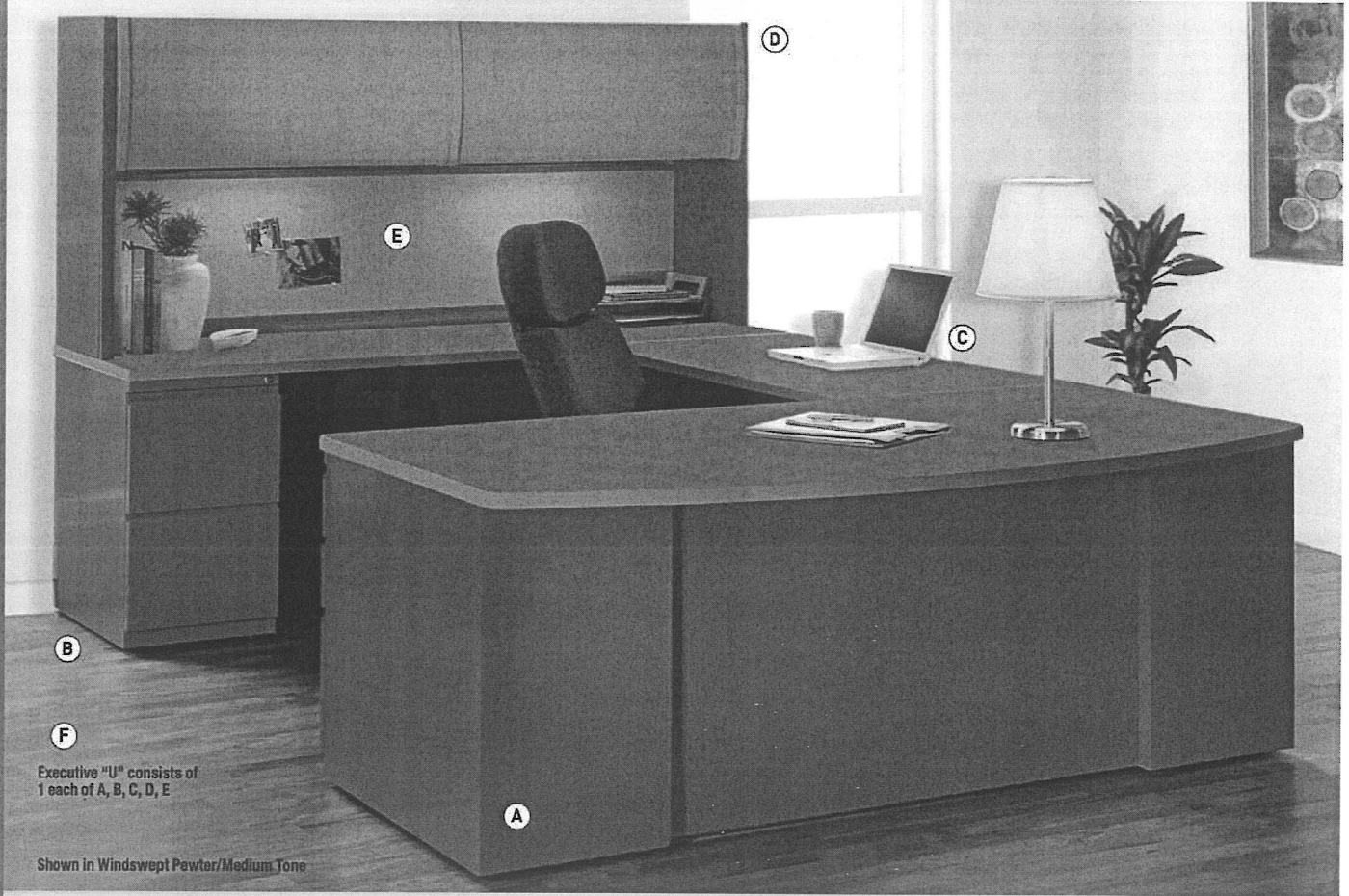

Executive "U" consists of 1 each of A, B, C, D, E

Shown in Windswept Pewter/Medium Tone

MAYLINE CSII Series

CARB Compliant

- Integrated pedestals can be installed to either right or left side of work surface
- High-pressure laminate tops with PVS edge treatments
- Wire grommets standard in all tops
- Optional center drawer
- Steel ball-bearing suspension and full-extension slides on all file drawers
- Limited lifetime warranty

Available in Classic Rock top/Desert Sage steel base/Taupe accents/Ray fabric (CLRDES) and Windswept Pewter top/Medium Tone steel base/Warm Gray accents/Khaki fabric (WSPMTN).

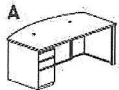

A. Bow Front Desk With Box/File Pedestal
72"W x 39"D x 29"H
MLN C1971

LIST PRICE
~~1499.00-EA~~

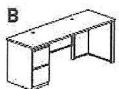

B. Credenza
72"W x 24"D x 29"H
MLN C1173
MLN C1171

File/File Pedestal
Box/Box/File Pedestal

1288.00-EA
1288.00-EA

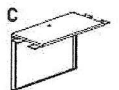

C. Bridge
42"W x 24"D x 29"H
MLN C282T

384.00-EA

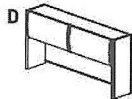

D. 72" Overhead Unit
72"W x 15"D x 36"H
MLN C747

LIST PRICE
~~1166.00-EA~~



E. Fabric Tack Panel
For 72" overhead.
69"W x 12"D x 17"H
MLN C867

368.00-EA

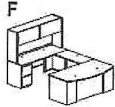

F. Executive U
Includes (1) each of A, B, C, D, E.
72"W x 105"D x 65"H
MLN CSU1

5437.00-EA

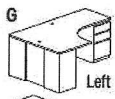

G. J-Tables (not shown)
J-Tables with 30" return and box/box/file pedestal.
72"W x 48"D x 29"H
MLN C343L1
MLN C343R1

Left
Right
1677.00-EA
1677.00-EA



H. P-Tables (not shown)
P-Tables with 30" return with conference end.
72"W x 48"D x 29"H
MLN C483L
MLN C483R

Left
Right
1333.00-EA
1333.00-EA

FA68

Available in 10-14 Business days



Additional items available from manufacturer.

Prices subject to change without notice. LA

OFFICE SUITES - Steel Desks



Furniture Advantage™

Extended Product Offering

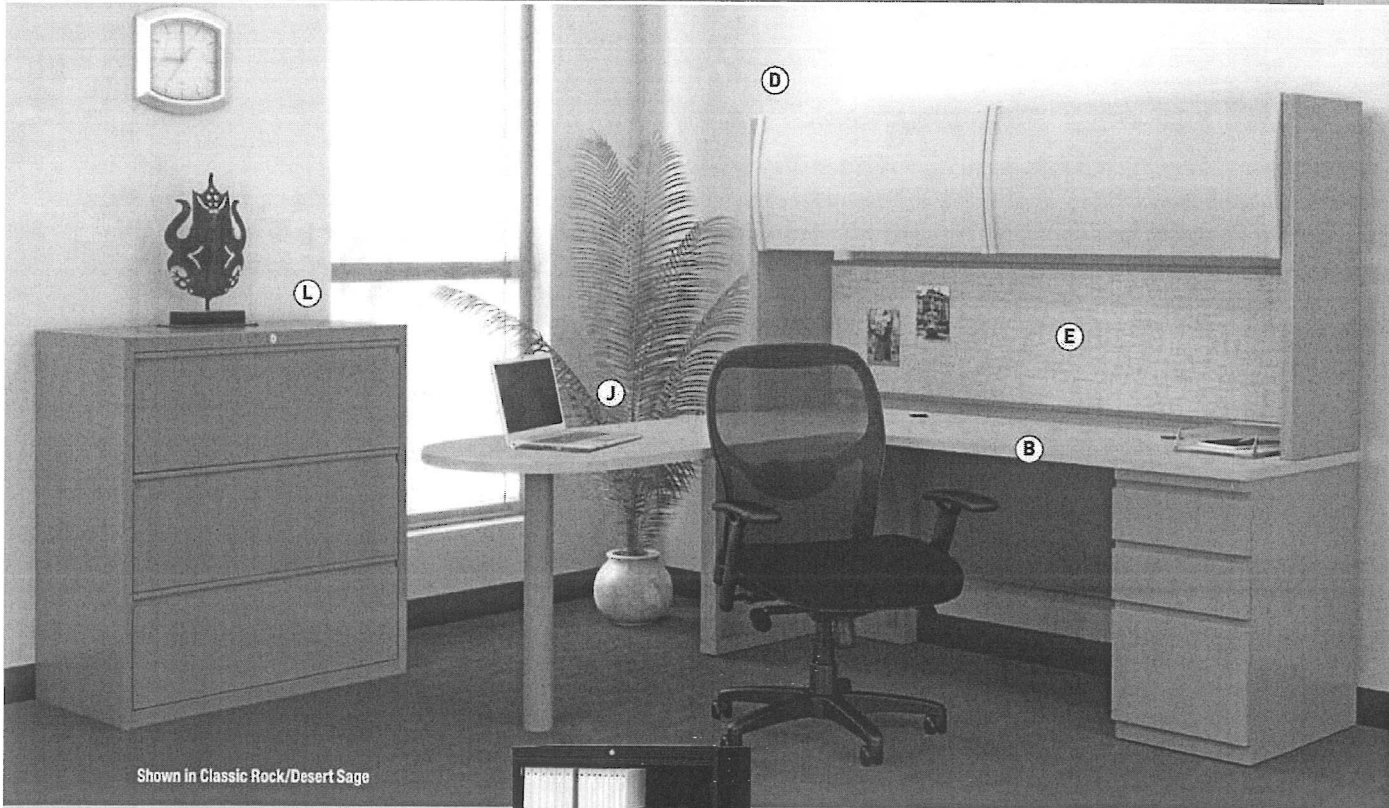

Shown in Classic Rock/Desert Sage

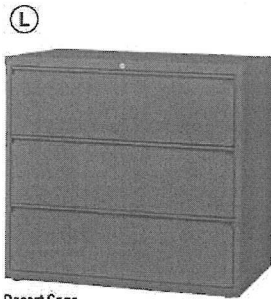

Desert Sage

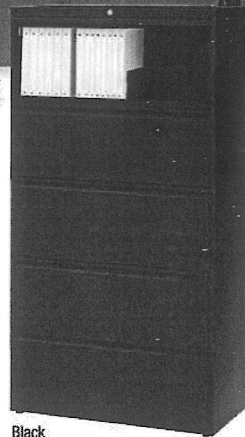

Black

I. J & P Suites (not shown)
Includes 1 of each D, E, G (Left), H (Right).
72"W x 102"D x 68"H
MLN CSJPHL _____ ‡
LIST PRICE 4625.00-EA

Includes 1 of each D, E, G (Right), H (Left).
72"W x 102"D x 68"H
MLN CSJPHR _____ ‡
4625.00-EA

J. Peninsula Desk
48"W x 24"D x 29"H
MLN C673 _____ ‡
667.00-EA

K. 2-Drawer Lateral File (not shown)
42"W x 18½"D x 28"H
MLN HLT422 _____ ‡ 995.00-EA
36"W x 18½"D x 28"H
MLN HLT362 _____ ‡ 852.00-EA
30"W x 18½"D x 28"H
MLN HLT302 _____ ‡ 710.00-EA

L. 3-Drawer Lateral File
42"W x 18½"D x 40½"H
MLN HLT423 _____ ‡ LIST PRICE 1166.00-EA
36"W x 18½"D x 40½"H
MLN HLT363 _____ ‡ 1020.00-EA
30"W x 18½"D x 40½"H
MLN HLT303 _____ ‡ 960.00-EA

M. 4-Drawer Lateral File (not shown)
42"W x 18½"D x 52½"H
MLN HLT424 _____ ‡ 1447.00-EA
36"W x 18½"D x 52½"H
MLN HLT364 _____ ‡ 1281.00-EA
30"W x 18½"D x 52½"H
MLN HLT304 _____ ‡ 1112.00-EA

N. 5-Drawer Lateral File
42"W x 18½"D x 67½"H
MLN HLT425 _____ ‡ 1727.00-EA
36"W x 18½"D x 67½"H
MLN HLT365 _____ ‡ 1613.00-EA
30"W x 18½"D x 67½"H
MLN HLT305 _____ ‡ 1515.00-EA

**FINISH SAMPLES A-J
FINISHES AND FABRICS - CLRDSE***

CLASSIC ROCK DESERT SAGE TAUPE RAY

*Classic Rock Desk Tops, Desert Sage Steel Base, Taupe Accents And Ray Fabric Tack Panel

FINISHES AND FABRICS - WSPMTN*

WINDSWEEP PEWTER MEDIUM TONE WARM GRAY KHAKI

*Windswept Pewter Desk Tops, Medium Tone Steel Base, Warm Gray Accents and Khaki Fabric Tack Panel

LATERAL FILE FINISH SAMPLES K-N

M5 DESERT SAGE R5 MEDIUM TONE S5 BLACK O6 MIST

O. Divider Kit (not shown) 10 pack.
MLN HLTDV10 LIST PRICE 85.00-PK

P. Front-To-Back Filing Rails (not shown) 4 pack.
MLN HLTFBRA 60.00-PK

Assembly needed. Please call for details.
‡Cannot be shipped UPS.
‡‡Cannot be shipped UPS Air. LA

Additional items available from manufacturer.

Available in 10-14 Business days **FA69**



OFFICE SUITES - Steel Desks

Furniture Advantage™

Extended Product Offering

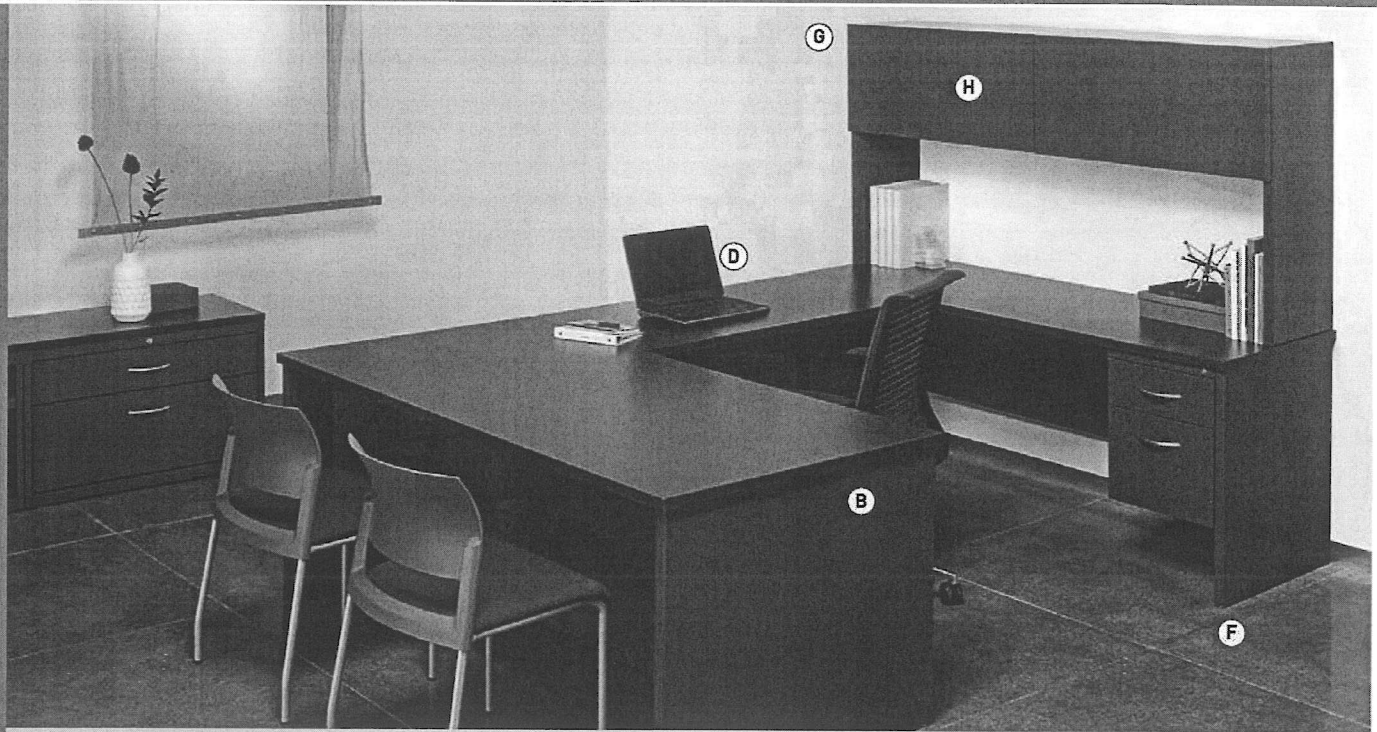

Modular Desking

- Precision ball-bearing slides provide full extension for all drawers
- Premium machined-edge banding
- Core removable lock
- Satin nickel arch pull handles
- Grommets for cord management
- Meets or exceeds ANSI/BIFMA standards
- Greenguard Gold certified
- Contains 28% recycled steel.

Available in Black/Walnut and Charcoal/Mahogany finishes.

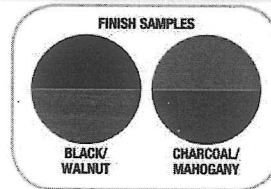

A. Double Pedestal Desk (not shown)

72"W x 36"D x 29½"H	Black/Walnut	LIST PRICE
HID 20531‡	Charcoal/Mahogany	1206.00-EA
HID 20532‡		1206.00-EA
60"W x 30"D x 29½"H	Black/Walnut	1166.00-EA
HID 20533‡	Charcoal/Mahogany	1166.00-EA
HID 20534‡		

B. Single Pedestal Desk

Right (not shown)		
72"W x 36"D x 29½"H	Black/Walnut	1076.00-EA
HID 20535‡	Charcoal/Mahogany	1076.00-EA
HID 20536‡		
66"W x 30"D x 29½"H	Black/Walnut	1020.00-EA
HID 20537‡	Charcoal/Mahogany	1020.00-EA
HID 20538‡		
48"W x 30"D x 29½"H	Black/Walnut	899.00-EA
HID 20539‡	Charcoal/Mahogany	899.00-EA
HID 20540‡		
Left		
72"W x 36"D x 29½"H	Black/Walnut	1076.00-EA
HID 20541‡	Charcoal/Mahogany	1076.00-EA
HID 20542‡		
66"W x 30"D x 29½"H	Black/Walnut	1020.00-EA
HID 20543‡	Charcoal/Mahogany	1020.00-EA
HID 20544‡		

C. Return (not shown)

Right		
48"W x 24"D x 29½"H	Black/Walnut	699.00-EA
HID 20545‡	Charcoal/Mahogany	699.00-EA
HID 20546‡		
Left		
48"W x 24"D x 29½"H	Black/Walnut	699.00-EA
HID 20547‡	Charcoal/Mahogany	699.00-EA
HID 20548‡		

D. Bridge

48"W x 24"D x 29½"H	Black/Walnut	369.00-EA
HID 20557‡	Charcoal/Mahogany	369.00-EA
HID 20558‡		

E. Double Pedestal Credenza (not shown)

72"W x 24"D x 29½"H	Black/Walnut	1079.00-EA
HID 20549‡	Charcoal/Mahogany	1079.00-EA
HID 20550‡		
60"W x 24"D x 29½"H	Black/Walnut	1036.00-EA
HID 20551‡	Charcoal/Mahogany	1036.00-EA
HID 20552‡		

F. Single Pedestal Credenza

Right		
72"W x 24"D x 29½"H	Black/Walnut	918.00-EA
HID 20553‡	Charcoal/Mahogany	918.00-EA
HID 20554‡		
Left (not shown)		
72"W x 24"D x 29½"H	Black/Walnut	918.00-EA
HID 20555‡	Charcoal/Mahogany	918.00-EA
HID 20556‡		

G. Stack-On Hutch

72"	72"W x 13½"D x 36½"H	Black	LIST PRICE
HID 20559‡	Charcoal	585.00-EA	
HID 20560‡		585.00-EA	
60"	60"W x 13½"D x 36½"H	Black	540.00-EA
HID 20561‡	Charcoal	540.00-EA	
HID 20562‡			
48"	48"W x 13½"D x 36½"H	Black	485.00-EA
HID 20563‡	Charcoal	485.00-EA	
HID 20564‡			

H. Door Kit For Stack-On Hutch

For 72" Stack-On Hutch – Two 36" doors			
36"W x 16"H	Black	325.00-EA	
HID 20565‡	Charcoal	325.00-EA	
HID 20566‡			
For 60" Stack-On Hutch – Two 30" doors			
30"W x 16"H	Black	307.00-EA	
HID 20567‡	Charcoal	307.00-EA	
HID 20568‡			
For 48" Stack-On Hutch – One 48" Door			
48"W x 16"H	Black	187.00-EA	
HID 20569‡	Charcoal	187.00-EA	
HID 20570‡			

FA70

Available in 10-14 Business days



Additional items available from manufacturer.

Prices subject to change without notice. LA